COMMERCIAL SHEET METAL



PRODUCT GUIDE

14th August 2023

Supercedes April 2022

ORDER PROCESSING

Brad

0450 088 161

DESPATCH AND QUOTES

Glen

ORDERS

orders@commercialsheetmetal.com.au

ESTIMATING

quotes@commercialsheetmetal.com.au

OFFICE

3803 3200

195 MAGNESIUM DRIVE

CRESTMead QLD 4132

INDEX

	Page
Stock Materials	
Bluescope	3
Delivery and Packaging	4
Flashings	6
Colorbond Range	7
Zincalume	11
Galvabond	13
Stainless Steel	17
Aluminium	22
Commercial Gutter Range	23
Half Round Gutter	26
Commercial High Front Slotted Eaves Gutter	29
OG Style Gutters	35
Quad Gutter	37
Light gauge Fabrication	38
Box Gutter & Accessories	41
Sumps	43
Rainheads	45
Round Downpipe	47
Rectangle Downpipe	51
Spiral Downpipe Range	54
Ridge Vents	59
Fixed Metal Louvre Range	60
Curved Flashings	62
Safe Trays	63
Other Items	64
Mesh	66
Welded Fabrication	
Bollard - Downpipe Protectors	67
Stainless Steel Welded Products	68
Sumps	70
Rainheads	72
Half Round Gutter	74
Downpipe	76
External Services	77
Technical Information	79



1200mm Wide Stock Coil - .55mm Standard Colorbond Range

Surfmist®	Evening Haze®	Shale Grey™	Dune®	Dover White
Windspray®	Gully™	Wallaby™	Jasper®	Basalt™
Manor Red®	Night Sky®	Deep Ocean®	Cottage Green®	Ironstone®
Monument®	Classic Cream™	Paperbark®	Pale Eucalypt®	Woodland Grey®
Southerly	Bluegum			

1200mm Wide Stock Coil - .55mm Premium Colorbond Range*

Ultra	Metallic	Matt	Others
Surfmist®	Aries®	Surfmist®	Cattai Green
Dune®	Astro®	Basalt™	Thredbo White
Windspray®	Celestian®		
Monument®	Rhea®	Monument®	Coolmax Whitehaven
Woodland Grey®	Galactic®		
	Cosmic®		
Deep Ocean®			

* Stock is limited for these ranges - Lead times are generally 4 weeks for extra supply

* Advise Job needs and we will pre order and hold in stock

1200mm Wide Stock Coil - 1mm and 1.2mm Colorbond Range

Surfmist®

1200mm Wide Stock Coil - Zinalume® and Galvabond®

Zinalume®

Galvabond®

.55mm	.8mm
1mm	1.2mm

.55mm	.8mm	1mm
1.2mm	1.6mm	
2mm	3.6 metre sheets	
3mm	3.6 metre sheets	

Deliveries

We have 4 vehicles on the road each day

We cover from The Tweed to Sunshine Coast and out to Ipswich Daily

We can arrange delivery to regional areas on request

Deliveries start from 5:30am and are complete most days by 1:30pm

Your Delivery Rates

Location		Location	
Brisbane	\$50.00	Gold Coast	\$50.00
North		South	
Caboolture	\$50.00	Tweed Heads	\$75.00
Kilcoy	\$125.00	Murwillumbah	\$100.00
Kingaroy	\$300.00	Byron Bay	\$150.00
Maroochydore	\$75.00	Ballina	\$200.00
Noosa	\$100.00	Lismore	\$200.00
Gympie	\$200.00	Grafton	\$450.00
Maryborough	\$350.00		
Bundaberg	\$550.00	West	
		Ipswich	\$50.00
		Gatton	\$75.00
South West		Toowoomba	\$125.00
Beaudesert	\$75.00	Oakey	\$175.00
Warwick	\$200.00		
Stanthorpe	\$300.00		

Packaging Options

PLASTIC WRAPPED

Plastic Wrapped with foam sections between flashings

\$7 per lineal metre of pack

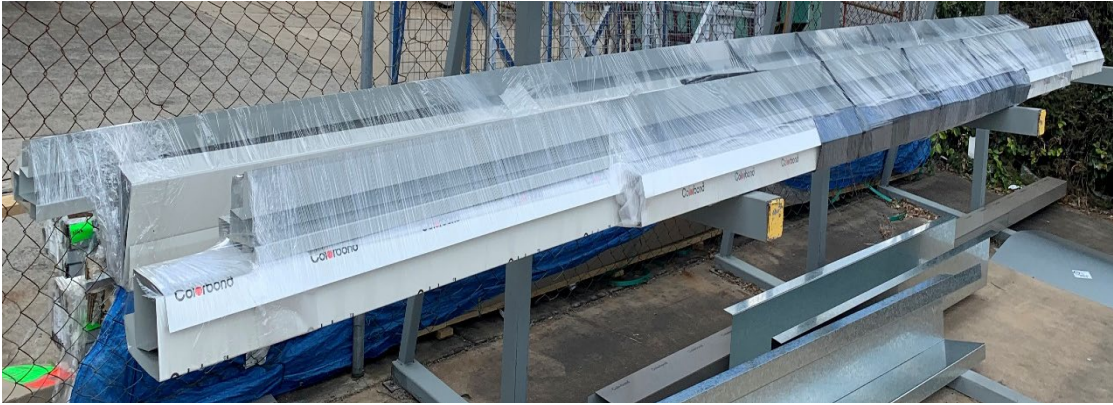

STILLAGES

Packed into Stillages - usually for long distance travel

\$45 per lineal metre of stillage

Stillage packing involves

Plastic wrapped around stillage



Goods placed inside stillage with foam, plastic corflute and tape for protection

.55mm Material folded into box gutter profile top and bottom



Flashings

Order by 4:00 pm for Next Day Availability

Up to 8 Metre Lengths

.55mm up to 1.6mm Thick

Up to 3.6 Metre Lengths for Heavy Gauge Materials

2mm and Up

Ability to fold any profile required on your Job

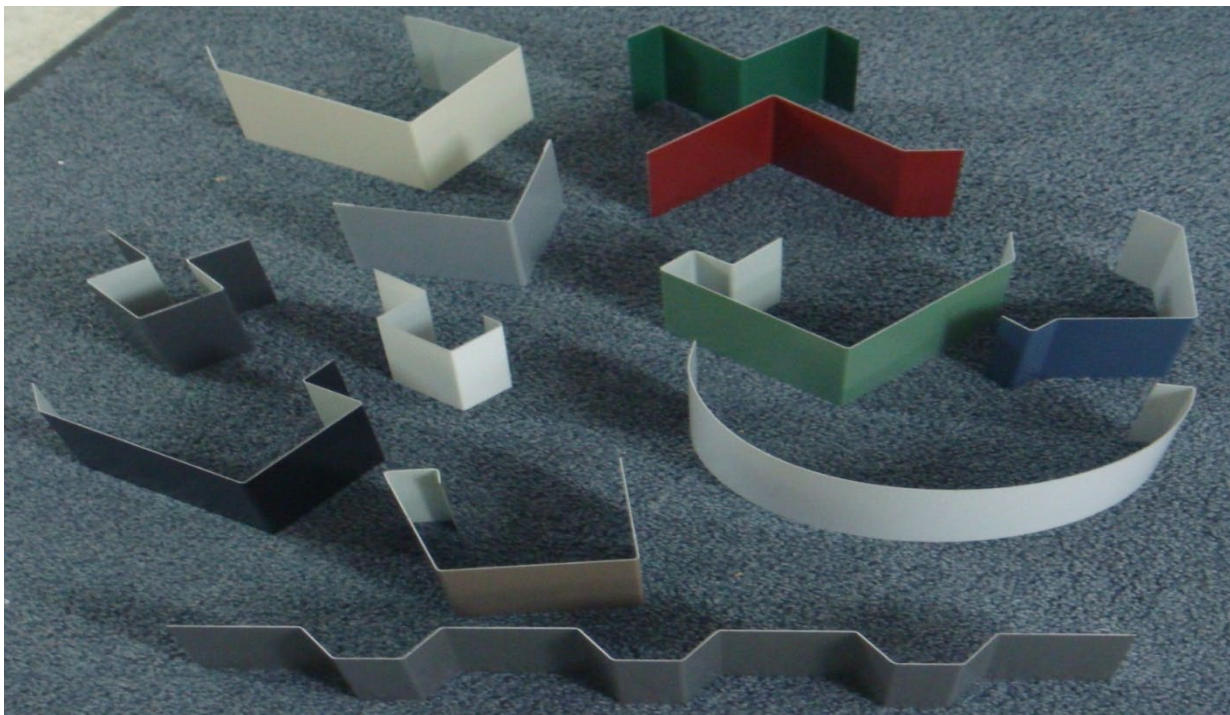

Preferred ordering method is via email with PDF attachment:

orders@commercialsheetmetal.com.au

1 Metre Minimum Charge for all Flashings

Squash Fold is charged as 2 folds

No Additional Charge for Taper Flashings



COLORBOND® XRW prepainted steel

AM100 G300S steel with Activate® technology

.55mm COLORBOND STANDARD RANGE

BENDS

GIRTH	FLAT	1	2	3	4	5	6	7	8
up to 100mm	5.31	6.15	7.00	7.85	8.70	9.55	10.39	11.24	12.09
101 to 150mm	6.84	7.69	8.53	9.38	10.23	11.08	11.93	12.77	13.62
151 to 200mm	8.37	9.22	10.06	10.91	11.76	12.61	13.46	14.30	15.15
201 to 240mm	9.59	10.44	11.29	12.14	12.99	13.83	14.68	15.53	16.38
241 to 300mm	11.43	12.28	13.13	13.98	14.82	15.67	16.52	17.37	18.22
301 to 400mm	14.49	15.34	16.19	17.04	17.89	18.73	19.58	20.43	21.28
401 to 500mm	18.78	19.63	20.48	21.33	22.17	23.02	23.87	24.72	25.57
501 to 600mm	19.74	20.59	21.44	22.29	23.14	23.98	24.83	25.68	26.53
601 to 800mm	27.97	28.82	29.66	30.51	31.36	32.21	33.06	33.90	34.75
801 to 1000mm	34.66	35.51	36.35	37.20	38.05	38.90	39.75	40.59	41.44
1001 to 1200mm	37.69	38.53	39.38	40.23	41.08	41.93	42.77	43.62	44.47

COLOURS WE STOCK - BLUESCOPE STANDARD RANGE

Basalt™	Dover White	Paperbark®
Classic Cream™	Ironstone®	Shale Grey™
Bluegum	Jasper®	Surfmist®
Cottage Green®	Manor Red®	Wallaby™
Deep Ocean®	Monument®	Woodland Grey®
Dune®	Night Sky®	Windspray®
Evening Haze®	Pale Eucalypt®	Southerley

COLOURS WE NO LONGER STOCK - Available on Request

Gully™

GST Exclusive # 1 metre minimum charge per flashing # Squash Fold is 2 bends # Valid from August 2023



COLORBOND® prepainted Matt finish steel, specifically designed by BlueScope to provide a highly durable, wall cladding and roofing material with a soft and subtle look for general use.

AM100 G300S steel with Activate® technology

COLORBOND® steel Matt

BENDS

GIRTH	FLAT	1	2	3	4	5	6	7	8
up to 100mm	6.64	7.49	8.34	9.19	10.03	10.88	11.73	12.58	13.43
101 to 200mm	10.60	11.45	12.30	13.14	13.99	14.84	15.69	16.54	17.38
201 to 300mm	14.56	15.40	16.25	17.10	17.95	18.80	19.64	20.49	21.34
301 to 400mm	18.51	19.36	20.21	21.06	21.91	22.75	23.60	24.45	25.30
401 to 600mm	26.43	27.28	28.12	28.97	29.82	30.67	31.52	32.36	33.21
601 to 900mm	44.23	45.08	45.93	46.78	47.63	48.47	49.32	50.17	51.02
901 to 1200mm	50.17	51.02	51.86	52.71	53.56	54.41	55.26	56.10	56.95

MATT RANGE - Refer to most recent Stock List for Availability

Surfmist®	Stocked	Dune®	Not Stocked
Monument®	Stocked	Shale Grey™	Not Stocked
Basalt™	Not Stocked		



COLORBOND® Ultra prepainted steel, specifically designed by BlueScope combines long term durability and excellent corrosion resistance.

AM150 G300S steel with Activate® technology

.55mm COLORBOND ULTRA

BENDS

GIRTH	FLAT	1	2	3	4	5	6	7	8
up to 100mm	7.18	8.03	8.87	9.72	10.57	11.42	12.27	13.11	13.96
101 to 200mm	11.67	12.52	13.36	14.21	15.06	15.91	16.76	17.60	18.45
201 to 300mm	16.16	17.01	17.86	18.70	19.55	20.40	21.25	22.10	22.94
301 to 400mm	20.65	21.50	22.35	23.20	24.04	24.89	25.74	26.59	27.44
401 to 600mm	29.64	30.48	31.33	32.18	33.03	33.88	34.72	35.57	36.42
601 to 900mm	49.85	50.70	51.54	52.39	53.24	54.09	54.94	55.78	56.63
901 to 1200mm	56.59	57.43	58.28	59.13	59.98	60.83	61.67	62.52	63.37

ULTRA RANGE - refer to most recent Stock List for Availability

Surfmist®	Stocked	## Any Colour can be Made in Ultra - Minimum Order Quantities and lead times apply ##
Monument®	Stocked	
Woodland Grey®	Stocked	
Windspray®	Stocked	
Dune®	Stocked	

GST Exclusive # 1 metre minimum charge per flashing # Squash Fold is 2 bends # Valid from August 2023



COLORBOND® Metallic prepainted steel has been designed by BlueScope to provide an aesthetically distinctive "metallic" effect.

AM100 G300S steel with Activate® technology

.55mm COLORBOND METALLIC

BENDS

GIRTH	FLAT	1	2	3	4	5	6	7	8
up to 100mm	8.57	9.42	10.26	11.11	11.96	12.81	13.66	14.50	15.35
101 to 200mm	14.45	15.30	16.15	16.99	17.84	18.69	19.54	20.39	21.23
201 to 300mm	20.33	21.18	22.03	22.88	23.72	24.57	25.42	26.27	27.12
301 to 400mm	26.21	27.06	27.91	28.76	29.61	30.45	31.30	32.15	33.00
401 to 600mm	37.98	38.83	39.67	40.52	41.37	42.22	43.07	43.91	44.76
601 to 900mm	64.45	65.29	66.14	66.99	67.84	68.69	69.53	70.38	71.23
901 to 1200mm	73.27	74.12	74.96	75.81	76.66	77.51	78.36	79.20	80.05

METALLIC RANGE - Refer to Most Recent Stock list for Availability

Aries

Astro

Celestian

Cosmic

Galactic

Rhea

.55mm Colorbond CATTAI GREEN / THREDBO WHITE G300S AM 100

BENDS

GIRTH	FLAT	1	2	3	4	5	6	7	8
up to 100mm	6.75	7.60	8.45	9.29	10.14	10.99	11.84	12.69	13.53
101 to 200mm	10.81	11.66	12.51	13.36	14.21	15.05	15.90	16.75	17.60
201 to 300mm	14.88	15.73	16.57	17.42	18.27	19.12	19.97	20.81	21.66
301 to 400mm	18.94	19.79	20.64	21.48	22.33	23.18	24.03	24.88	25.72
401 to 600mm	25.91	26.76	27.60	28.45	29.30	30.15	31.00	31.84	32.69
601 to 900mm	45.36	46.20	47.05	47.90	48.75	49.60	50.44	51.29	52.14
901 to 1200mm	51.45	52.30	53.15	54.00	54.84	55.69	56.54	57.39	58.24

.55mm Colorbond COOLMAX WHITEHAVEN G300S AM 100

BENDS

GIRTH	FLAT	1	2	3	4	5	6	7	8
up to 100mm	7.18	8.03	8.87	9.72	10.57	11.42	12.27	13.11	13.96
101 to 200mm	11.67	12.52	13.36	14.21	15.06	15.91	16.76	17.60	18.45
201 to 300mm	16.16	17.01	17.86	18.70	19.55	20.40	21.25	22.10	22.94
301 to 400mm	20.65	21.50	22.35	23.20	24.04	24.89	25.74	26.59	27.44
401 to 600mm	28.35	29.20	30.05	30.90	31.74	32.59	33.44	34.29	35.14
601 to 900mm	49.85	50.70	51.54	52.39	53.24	54.09	54.94	55.78	56.63
901 to 1200mm	56.59	57.43	58.28	59.13	59.98	60.83	61.67	62.52	63.37

WE HOLD LIMITED STOCKS OF MATERIAL LISTED ON THIS PAGE - ADVISE PRIOR TO A PROJECT COMMENCING

GST Exclusive # 1 metre minimum charge per flashing # Squash Fold is 2 bends # Valid from August 2023



1mm COLORBOND SURFMIST

BENDS									
GIRTH	FLAT	1	2	3	4	5	6	7	8
up to 100mm	10.14	11.55	12.96	14.38	15.79	17.20	18.62	20.03	21.44
101 to 200mm	15.79	17.21	18.62	20.03	21.45	22.86	24.27	25.69	27.10
201 to 300mm	21.45	22.87	24.28	25.69	27.11	28.52	29.93	31.35	32.76
301 to 400mm	27.11	28.53	29.94	31.35	32.77	34.18	35.59	37.01	38.42
401 to 600mm	38.43	39.85	41.26	42.67	44.09	45.50	46.91	48.33	49.74
601 to 900mm	63.90	65.31	66.73	68.14	69.55	70.97	72.38	73.79	75.21
901 to 1200mm	72.39	73.80	75.22	76.63	78.04	79.46	80.87	82.28	83.70

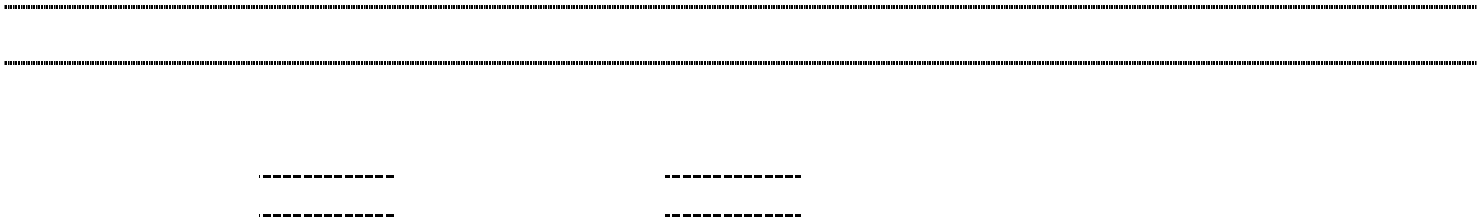

1.2mm COLORBOND SURFMIST

BENDS									
GIRTH	FLAT	1	2	3	4	5	6	7	8
up to 100mm	12.03	13.72	15.42	17.12	18.81	20.51	22.20	23.90	25.60
101 to 200mm	18.69	20.38	22.08	23.78	25.47	27.17	28.86	30.56	32.26
201 to 300mm	25.35	27.04	28.74	30.43	32.13	33.83	35.52	37.22	38.91
301 to 400mm	32.00	33.70	35.40	37.09	38.79	40.48	42.18	43.88	45.57
401 to 600mm	45.32	47.02	48.71	50.41	52.10	53.80	55.50	57.19	58.89
601 to 900mm	75.28	76.98	78.67	80.37	82.07	83.76	85.46	87.15	88.85
901 to 1200mm	85.27	86.97	88.66	90.36	92.05	93.75	95.45	97.14	98.84

GST Exclusive # 1 metre minimum charge per flashing # Squash Fold is 2 bends # Valid from August 2023



ZINCALUME® G300 steel with Activate® technology is a hot-dipped aluminium / zinc / magnesium alloy coated structural steel with a regular spangle surface, a guaranteed minimum yield strength of 300MPa with good ductility.

.55mm ZINCALUME G300 AM 125

BENDS

GIRTH	FLAT	1	2	3	4	5	6	7	8
up to 100mm	4.92	5.77	6.61	7.46	8.31	9.16	10.01	10.85	11.70
101 to 150mm	6.25	7.10	7.95	8.80	9.65	10.49	11.34	12.19	13.04
151 to 200mm	7.59	8.44	9.29	10.13	10.98	11.83	12.68	13.53	14.37
201 to 240mm	8.66	9.51	10.36	11.20	12.05	12.90	13.75	14.60	15.44
241 to 300mm	10.26	11.11	11.96	12.81	13.66	14.50	15.35	16.20	17.05
301 to 400mm	12.43	13.28	14.12	14.97	15.82	16.67	17.52	18.36	19.21
401 to 500mm	16.68	17.53	18.38	19.23	20.07	20.92	21.77	22.62	23.47
501 to 600mm	17.52	18.37	19.22	20.07	20.91	21.76	22.61	23.46	24.31
601 to 800mm	24.70	25.55	26.40	27.25	28.09	28.94	29.79	30.64	31.49
801 to 1000mm	29.96	30.80	31.65	32.50	33.35	34.20	35.04	35.89	36.74
1001 to 1200mm	33.24	34.09	34.94	35.78	36.63	37.48	38.33	39.18	40.02

.8mm ZINCALUME G300 AM 125

BENDS

GIRTH	FLAT	1	2	3	4	5	6	7	8
up to 100mm	7.15	8.28	9.41	10.54	11.67	12.80	13.93	15.06	16.19
101 to 200mm	10.71	11.84	12.97	14.10	15.23	16.36	17.49	18.62	19.76
201 to 300mm	14.27	15.41	16.54	17.67	18.80	19.93	21.06	22.19	23.32
301 to 400mm	17.84	18.97	20.10	21.23	22.36	23.49	24.62	25.75	26.89
401 to 600mm	24.97	26.10	27.23	28.36	29.49	30.62	31.75	32.88	34.01
601 to 900mm	38.87	40.00	41.13	42.26	43.39	44.53	45.66	46.79	47.92
901 to 1200mm	46.36	47.49	48.62	49.75	50.88	52.01	53.14	54.27	55.40

GST Exclusive # 1 metre minimum charge per flashing # Squash Fold is 2 bends # Valid from August 2023



ZINCALUME® G300 steel with Activate® technology is a hot-dipped aluminium / zinc / magnesium alloy coated structural steel with a regular spangle surface, a guaranteed minimum yield strength of 300MPa with good ductility.

1mm ZINCALUME G300 AM 125

BENDS

GIRTH	FLAT	1	2	3	4	5	6	7	8
up to 100mm	8.93	10.34	11.76	13.17	14.58	16.00	17.41	18.82	20.24
101 to 200mm	13.39	14.80	16.21	17.63	19.04	20.45	21.87	23.28	24.69
201 to 300mm	17.84	19.26	20.67	22.08	23.50	24.91	26.32	27.74	29.15
301 to 400mm	22.30	23.71	25.13	26.54	27.95	29.37	30.78	32.19	33.61
401 to 600mm	31.21	32.63	34.04	35.45	36.87	38.28	39.69	41.11	42.52
601 to 900mm	51.26	52.68	54.09	55.50	56.92	58.33	59.74	61.16	62.57
901 to 1200mm	57.95	59.36	60.77	62.19	63.60	65.01	66.43	67.84	69.25

1.2mm ZINCALUME G300 AM 125

BENDS

GIRTH	FLAT	1	2	3	4	5	6	7	8
up to 100mm	10.72	12.41	14.11	15.81	17.50	19.20	20.89	22.59	24.29
101 to 200mm	16.07	17.76	19.46	21.15	22.85	24.55	26.24	27.94	29.63
201 to 300mm	21.41	23.11	24.80	26.50	28.20	29.89	31.59	33.28	34.98
301 to 400mm	26.76	28.46	30.15	31.85	33.54	35.24	36.94	38.63	40.33
401 to 600mm	37.45	39.15	40.85	42.54	44.24	45.93	47.63	49.33	51.02
601 to 900mm	58.31	60.00	61.70	63.40	65.09	66.79	68.48	70.18	71.88
901 to 1200mm	69.54	71.23	72.93	74.63	76.32	78.02	79.71	81.41	83.11

GST Exclusive # 1 metre minimum charge per flashing # Squash Fold is 2 bends # Valid from August 2023



GALVABOND® steel G2

BlueScope Steel GALVABOND® steel range designed for commercial forming and deep drawing applications with optional improved surface quality.

.55mm GALVABOND G2 Z275									
BENDS									
GIRTH	FLAT	1	2	3	4	5	6	7	8
up to 100mm	5.55	6.40	7.25	8.10	8.95	9.79	10.64	11.49	12.34
101 to 200mm	8.42	9.27	10.12	10.97	11.81	12.66	13.51	14.36	15.21
201 to 300mm	11.29	12.14	12.99	13.83	14.68	15.53	16.38	17.23	18.07
301 to 400mm	14.16	15.01	15.85	16.70	17.55	18.40	19.25	20.09	20.94
401 to 600mm	19.89	20.74	21.59	22.44	23.29	24.13	24.98	25.83	26.68
601 to 900mm	26.78	27.63	28.47	29.32	30.17	31.02	31.87	32.71	33.56
901 to 1200mm	37.10	37.95	38.80	39.65	40.49	41.34	42.19	43.04	43.89
1201 to 1500mm*	50.09	51.23	52.38	53.52	54.67	55.81	56.96	58.10	59.25

.8mm GALVABOND G2 Z275									
BENDS									
GIRTH	FLAT	1	2	3	4	5	6	7	8
up to 100mm	7.49	8.62	9.75	10.88	12.01	13.14	14.28	15.41	16.54
101 to 200mm	11.40	12.53	13.66	14.79	15.93	17.06	18.19	19.32	20.45
201 to 300mm	15.31	16.44	17.57	18.71	19.84	20.97	22.10	23.23	24.36
301 to 400mm	19.22	20.36	21.49	22.62	23.75	24.88	26.01	27.14	28.27
401 to 600mm	27.05	28.18	29.31	30.44	31.57	32.70	33.83	34.96	36.09
601 to 900mm	36.43	37.56	38.69	39.82	40.96	42.09	43.22	44.35	45.48
901 to 1200mm	50.51	51.64	52.77	53.90	55.03	56.17	57.30	58.43	59.56
1201 to 1500mm*	68.19	69.72	71.24	72.77	74.30	75.82	77.35	78.88	80.40

1mm GALVABOND G2 Z275									
BENDS									
GIRTH	FLAT	1	2	3	4	5	6	7	8
up to 100mm	9.23	10.64	12.05	13.47	14.88	16.29	17.71	19.12	20.53
101 to 200mm	13.98	15.39	16.80	18.22	19.63	21.04	22.46	23.87	25.28
201 to 300mm	18.73	20.14	21.55	22.97	24.38	25.79	27.21	28.62	30.03
301 to 400mm	23.48	24.89	26.30	27.72	29.13	30.54	31.96	33.37	34.78
401 to 600mm	32.98	34.39	35.80	37.22	38.63	40.04	41.46	42.87	44.28
601 to 900mm	44.38	45.79	47.20	48.62	50.03	51.44	52.86	54.27	55.68
901 to 1200mm	61.48	62.89	64.30	65.72	67.13	68.54	69.96	71.37	72.78
1201 to 1500mm*	82.99	84.90	86.81	88.72	90.62	92.53	94.44	96.35	98.26

* 1500mm Sheet Generally Available in 2.4 metre and 3.0 metre lengths - Buy in on Request

GST Exclusive # 1 metre minimum charge per flashing # Squash Fold is 2 bends # Valid from August 2023



GALVABOND® steel G2

BlueScope Steel GALVABOND® steel range designed for commercial forming and deep drawing applications with optional improved surface quality.

1.2mm GALVABOND G2 Z275

BENDS

GIRTH	FLAT	1	2	3	4	5	6	7	8
up to 100mm	11.07	12.76	14.46	16.16	17.85	19.55	21.24	22.94	24.64
101 to 200mm	16.77	18.46	20.16	21.85	23.55	25.25	26.94	28.64	30.33
201 to 300mm	22.46	24.16	25.86	27.55	29.25	30.94	32.64	34.34	36.03
301 to 400mm	28.16	29.86	31.55	33.25	34.95	36.64	38.34	40.03	41.73
401 to 600mm	39.56	41.25	42.95	44.64	46.34	48.04	49.73	51.43	53.12
601 to 900mm	53.23	54.93	56.62	58.32	60.02	61.71	63.41	65.10	66.80
901 to 1200mm	73.74	75.44	77.13	78.83	80.53	82.22	83.92	85.61	87.31
1201 to 1500mm*	99.55	101.84	104.13	106.42	108.71	111.00	113.29	115.58	117.87

* 1500mm Sheet Generally Available in 2.4 metre and 3.0 metre lengths - Buy in on Request

1.6mm GALVABOND G2 Z275

BENDS

GIRTH	FLAT	1	2	3	4	5	6	7	8
up to 100mm	14.37	16.63	18.89	21.15	23.41	25.67	27.93	30.20	32.46
101 to 200mm	21.57	23.83	26.10	28.36	30.62	32.88	35.14	37.40	39.66
201 to 300mm	28.78	31.04	33.30	35.56	37.82	40.09	42.35	44.61	46.87
301 to 400mm	35.98	38.25	40.51	42.77	45.03	47.29	49.55	51.81	54.08
401 to 600mm	50.40	52.66	54.92	57.18	59.44	61.70	63.96	66.23	68.49
601 to 900mm	84.98	87.25	89.51	91.77	94.03	96.29	98.55	100.81	103.08
901 to 1200mm	93.63	95.89	98.15	100.42	102.68	104.94	107.20	109.46	111.72
1201 to 1500mm*	126.40	129.46	132.51	135.56	138.61	141.67	144.72	147.77	150.82

* 1500mm Sheet Generally Available in 2.4 metre and 3.0 metre lengths - Buy in on Request

1.6mm Galvabond Stocked in Coil x 1200 wide and Sheet - 1200 x 3600

GST Exclusive # 1 metre minimum charge per flashing # Squash Fold is 2 bends # Valid from August 2023

Squash Fold Not Available on 1.6mm



GALVABOND® steel G2

BlueScope Steel GALVABOND® steel range designed for commercial forming and deep drawing applications with optional improved surface quality.

2mm GALVABOND G2 Z275

BENDS

GIRTH	FLAT	1	2	3	4	5	6	7	8
up to 100mm	18.56	21.39	24.21	27.04	29.87	32.69	35.52	38.35	41.17
101 to 200mm	28.17	30.99	33.82	36.65	39.47	42.30	45.13	47.95	50.78
201 to 300mm	37.77	40.60	43.43	46.25	49.08	51.91	54.73	57.56	60.39
301 to 400mm	47.38	50.21	53.04	55.86	58.69	61.52	64.34	67.17	70.00
401 to 600mm	66.60	69.42	72.25	75.08	77.90	80.73	83.56	86.38	89.21
601 to 900mm	112.72	115.54	118.37	121.20	124.02	126.85	129.68	132.50	135.33
901 to 1200mm	124.25	127.07	129.90	132.73	135.55	138.38	141.21	144.03	146.86

2mm GALVABOND STOCKED IN 1200mm x 3600mm SHEETS

3mm GALVABOND G2 Z275

BENDS

GIRTH	FLAT	1	2	3	4	5	6	7	8
up to 100mm	27.43	31.67	35.91	40.15	44.39	48.63	52.87	57.11	61.35
101 to 200mm	41.43	45.67	49.91	54.15	58.39	62.63	66.87	71.11	75.35
201 to 300mm	55.43	59.67	63.91	68.15	72.39	76.63	80.87	85.11	89.35
301 to 400mm	69.43	73.67	77.91	82.15	86.39	90.63	94.87	99.11	103.35
401 to 600mm	97.43	101.67	105.91	110.15	114.39	118.63	122.87	127.11	131.35
601 to 900mm	164.63	168.87	173.11	177.35	181.59	185.83	190.07	194.31	198.55
901 to 1200mm	181.43	185.67	189.91	194.15	198.39	202.63	206.87	211.11	215.35

3mm GALVABOND STOCKED IN 1200mm x 3600mm SHEETS

GST Exclusive # 1 metre minimum charge per flashing # Squash Fold is N/A # Valid from August 2023

FLAT STRAP UP TO 50mm WIDE

	.55mm	.8mm	1mm	1.2mm	1.5mm	2mm	3mm
ZINCALUME	4.81	5.23	6.54	7.85	X	X	X
COLORBOND	4.99	X	7.11	8.47	X	X	X
GALVABOND	4.90	5.40	6.68	8.01	8.73	11.64	15.50
304 STAINLESS	7.47	X	X	14.15	16.20	21.23	30.97
316 STAINLESS	8.39	X	X	16.24	18.76	24.57	36.18
ALUMINIUM	X	X	6.92	X	X	X	X

Extra Bends - Flashings

For Each additional Bend after 8 bends

Material Thickness	Per Bend & Per Metre
.55mm	0.85
.8mm	1.13
1.0mm	1.41
1.2mm	1.70
1.6mm	2.26
2.0mm	2.83
3.0mm	4.24

GST Exclusive # 1 metre minimum charge per flashing # Valid from August 2023

Stainless Steel

STOCK MATERIAL - .55mm

304 2b

316 2b

STOCK MATERIAL - 1.2mm

304 No 4

316 No 4

STOCK MATERIAL - 1.6mm

304 No 4

316 No 4

Aluminium

STOCK MATERIAL - 1mm

5005 grade Mill finish

Stainless Steel - Stock Flashing Feed

.55mm 304 2b GRADE STAINLESS STEEL									
BENDS									
GIRTH	FLAT	1	2	3	4	5	6	7	8
up to 100mm	10.95	11.80	12.65	13.49	14.34	15.19	16.04	16.89	17.73
101 to 200mm	19.21	20.06	20.91	21.76	22.61	23.45	24.30	25.15	26.00
201 to 300mm	27.48	28.33	29.17	30.02	30.87	31.72	32.57	33.41	34.26
301 to 400mm	35.74	36.59	37.44	38.28	39.13	39.98	40.83	41.68	42.52
401 to 600mm	52.27	53.12	53.96	54.81	55.66	56.51	57.36	58.20	59.05
601 to 900mm	84.50	85.35	86.19	87.04	87.89	88.74	89.59	90.43	91.28
901 to 1200mm	101.85	102.70	103.55	104.40	105.24	106.09	106.94	107.79	108.64

.55mm 316 2b GRADE STAINLESS STEEL									
BENDS									
GIRTH	FLAT	1	2	3	4	5	6	7	8
up to 100mm	12.89	13.74	14.59	15.44	16.29	17.13	17.98	18.83	19.68
101 to 200mm	23.10	23.95	24.80	25.65	26.49	27.34	28.19	29.04	29.89
201 to 300mm	33.31	34.16	35.01	35.85	36.70	37.55	38.40	39.25	40.09
301 to 400mm	43.52	44.37	45.21	46.06	46.91	47.76	48.61	49.45	50.30
401 to 600mm	63.94	64.78	65.63	66.48	67.33	68.18	69.02	69.87	70.72
601 to 900mm	110.49	111.33	112.18	113.03	113.88	114.73	115.57	116.42	117.27
901 to 1200mm	125.19	126.03	126.88	127.73	128.58	129.43	130.27	131.12	131.97

1.2mm 304 GRADE STAINLESS STEEL									
BENDS									
GIRTH	FLAT	1	2	3	4	5	6	7	8
up to 100mm	23.96	25.66	27.36	29.05	30.75	32.44	34.14	35.84	37.53
101 to 200mm	42.56	44.25	45.95	47.65	49.34	51.04	52.73	54.43	56.13
201 to 300mm	61.15	62.85	64.54	66.24	67.94	69.63	71.33	73.02	74.72
301 to 400mm	79.75	81.44	83.14	84.83	86.53	88.23	89.92	91.62	93.31
401 to 600mm	116.93	118.63	120.33	122.02	123.72	125.41	127.11	128.81	130.50
601 to 900mm	195.03	196.72	198.42	200.11	201.81	203.51	205.20	206.90	208.59
901 to 1200mm	217.87	219.57	221.26	222.96	224.65	226.35	228.05	229.74	231.44

1.2mm 316 GRADE STAINLESS STEEL									
BENDS									
GIRTH	FLAT	1	2	3	4	5	6	7	8
up to 100mm	28.34	30.04	31.73	33.43	35.12	36.82	38.52	40.21	41.91
101 to 200mm	51.31	53.00	54.70	56.40	58.09	59.79	61.48	63.18	64.88
201 to 300mm	74.28	75.97	77.67	79.36	81.06	82.76	84.45	86.15	87.84
301 to 400mm	97.25	98.94	100.64	102.33	104.03	105.73	107.42	109.12	110.81
401 to 600mm	143.18	144.88	146.58	148.27	149.97	151.66	153.36	155.06	156.75
601 to 900mm	235.06	236.75	238.45	240.15	241.84	243.54	245.23	246.93	248.63
901 to 1200mm	267.87	269.57	271.26	272.96	274.65	276.35	278.05	279.74	281.44

GST Exclusive # 1 metre minimum charge per flashing # Squash Fold is 2 bends # Valid from August 2023

Stainless Steel - Stock Flashing Feed

1.5mm 304 GRADE STAINLESS STEEL									
BENDS									
GIRTH	FLAT	1	2	3	4	5	6	7	8
up to 100mm	28.23	30.35	32.47	34.59	36.71	38.83	40.95	43.07	45.19
101 to 200mm	51.11	53.23	55.35	57.47	59.59	61.71	63.83	65.95	68.07
201 to 300mm	74.00	76.12	78.24	80.36	82.48	84.60	86.72	88.84	90.96
301 to 400mm	96.88	99.00	101.12	103.24	105.36	107.48	109.60	111.72	113.84
401 to 600mm	142.65	144.77	146.89	149.01	151.13	153.25	155.37	157.49	159.61
601 to 900mm	245.63	247.75	249.87	251.99	254.11	256.23	258.35	260.47	262.59
901 to 1200mm	266.88	269.00	271.12	273.24	275.36	277.48	279.60	281.72	283.84
1201 to 1500mm*	360.29	363.15	366.02	368.88	371.74	374.60	377.46	380.33	383.19

* 1500mm Sheet Generally Available in 2.4 metre and 3.0 metre lengths - Buy in on Request

1.5mm 316 GRADE STAINLESS STEEL									
BENDS									
GIRTH	FLAT	1	2	3	4	5	6	7	8
up to 100mm	33.61	35.73	37.85	39.97	42.09	44.21	46.33	48.45	50.57
101 to 200mm	61.88	64.00	66.12	68.24	70.36	72.48	74.60	76.72	78.84
201 to 300mm	90.15	92.27	94.39	96.51	98.63	100.75	102.87	104.99	107.11
301 to 400mm	118.42	120.54	122.66	124.78	126.90	129.02	131.14	133.26	135.38
401 to 600mm	174.96	177.08	179.20	181.32	183.44	185.56	187.68	189.80	191.92
601 to 900mm	303.87	305.99	308.11	310.23	312.35	314.47	316.59	318.71	320.83
901 to 1200mm	344.57	346.69	348.81	350.93	353.05	355.17	357.29	359.41	361.53
1201 to 1500mm*	465.18	468.04	470.90	473.76	476.62	479.49	482.35	485.21	488.07

* 1500mm Sheet Generally Available in 2.4 metre and 3.0 metre lengths - Buy in on Request

GST Exclusive # 1 metre minimum charge per flashing # Squash Fold is N/A # Valid from August 2023

Stainless Steel - Heavy Guage on Sheet

STAINLESS STEEL IN SHEET FORM - Usually 2.4, 3.0 or 3.6 Metre - NOT STOCK

2mm 304 GRADE STAINLESS STEEL

BENDS

GIRTH	FLAT	1	2	3	4	5	6	7	8
up to 200mm	76.04	78.86	81.69	84.52	87.34	90.17	93.00	95.82	98.65
201 to 400mm	123.64	126.46	129.29	132.12	134.94	137.77	140.60	143.42	146.25
401 to 600mm	183.14	185.96	188.79	191.62	194.44	197.27	200.10	202.92	205.75
601 to 900mm	317.01	319.84	322.67	325.49	328.32	331.15	333.97	336.80	339.63
901 to 1200mm	361.64	364.46	367.29	370.12	372.94	375.77	378.60	381.42	384.25
1201 to 1500mm*	488.21	492.03	495.84	499.66	503.47	507.29	511.11	514.92	518.74

* 1500mm Sheet Generally Available in 2.4 metre and 3.0 metre lengths - Buy in on Request

2mm 316 GRADE STAINLESS STEEL

BENDS

GIRTH	FLAT	1	2	3	4	5	6	7	8
up to 200mm	78.14	80.96	83.79	86.62	89.44	92.27	95.10	97.92	100.75
201 to 400mm	151.64	154.46	157.29	160.12	162.94	165.77	168.60	171.42	174.25
401 to 600mm	225.14	227.96	230.79	233.62	236.44	239.27	242.10	244.92	247.75
601 to 900mm	401.54	404.36	407.19	410.02	412.84	415.67	418.50	421.32	424.15
901 to 1200mm	445.64	448.46	451.29	454.12	456.94	459.77	462.60	465.42	468.25
1201 to 1500mm*	601.61	605.43	609.24	613.06	616.87	620.69	624.51	628.32	632.14

* 1500mm Sheet Generally Available in 2.4 metre and 3.0 metre lengths - Buy in on Request

GST Exclusive # 1 metre mininum charge per flashing # Squash Fold is N/A # Valid from August 2023

Stainless Steel - Heavy Guage on Sheet

STAINLESS STEEL IN SHEET FORM - Usually 2.4, 3.0 or 3.6 Metre - NOT STOCK

3mm 304 GRADE STAINLESS STEEL

BENDS

GIRTH	FLAT	1	2	3	4	5	6	7	8
up to 200mm	96.19	100.43	104.67	108.91	113.15	117.39	121.63	125.87	130.11
201 to 400mm	189.16	193.40	197.64	201.88	206.12	210.36	214.60	218.84	223.08
401 to 600mm	282.13	286.37	290.61	294.85	299.09	303.33	307.57	311.81	316.05
601 to 900mm	491.31	495.55	499.79	504.03	508.27	512.51	516.75	520.99	525.23
901 to 1200mm	561.04	565.28	569.52	573.76	578.00	582.24	586.48	590.72	594.96
1201 to 1500mm*	757.40	763.12	768.85	774.57	780.30	786.02	791.74	797.47	803.19

* 1500mm Sheet Generally Available in 2.4 metre and 3.0 metre lengths - Buy in on Request

3mm 316 GRADE STAINLESS STEEL

BENDS

GIRTH	FLAT	1	2	3	4	5	6	7	8
up to 200mm	118.07	122.31	126.55	130.79	135.03	139.27	143.51	147.75	151.99
201 to 400mm	232.91	237.15	241.39	245.63	249.87	254.11	258.35	262.59	266.83
401 to 600mm	347.76	352.00	356.24	360.48	364.72	368.96	373.20	377.44	381.68
601 to 900mm	623.38	627.62	631.86	636.10	640.34	644.58	648.82	653.06	657.30
901 to 1200mm	692.29	696.53	700.77	705.01	709.25	713.49	717.73	721.97	726.21
1201 to 1500mm*	934.59	940.31	946.03	951.76	957.48	963.21	968.93	974.65	980.38

* 1500mm Sheet Generally Available in 2.4 metre and 3.0 metre lengths - Buy in on Request

GST Exclusive # 1 metre mininum charge per flashing # Squash Fold is N/A # Valid from August 2023

1mm ALUMINIUM MILL FINISH 5005 GRADE - STOCKED ON 1200mm WIDE COIL**BENDS**

GIRTH	FLAT	1	2	3	4	5	6	7	8
up to 100mm	9.73	11.14	12.55	13.97	15.38	16.79	18.21	19.62	21.03
101 to 200mm	14.98	16.39	17.80	19.22	20.63	22.04	23.46	24.87	26.28
201 to 300mm	20.23	21.64	23.05	24.47	25.88	27.29	28.71	30.12	31.53
301 to 400mm	25.48	26.89	28.30	29.72	31.13	32.54	33.96	35.37	36.78
401 to 600mm	35.98	37.39	38.80	40.22	41.63	43.04	44.46	45.87	47.28
601 to 900mm	59.60	61.01	62.43	63.84	65.25	66.67	68.08	69.49	70.91
901 to 1200mm	67.48	68.89	70.30	71.72	73.13	74.54	75.96	77.37	78.78

ALUMINIUM IN SHEET FORM - Usually 2.4, 3.0 or 3.6 Metre - NOT STOCKED**1.6mm ALUMINIUM MILL FINISH 5005 GRADE - SHEET BUY IN****BENDS**

GIRTH	FLAT	1	2	3	4	5	6	7	8
up to 200mm	23.96	26.22	28.48	30.74	33.01	35.27	37.53	39.79	42.05
201 to 400mm	40.76	43.02	45.28	47.54	49.81	52.07	54.33	56.59	58.85
401 to 600mm	57.56	59.82	62.08	64.34	66.61	68.87	71.13	73.39	75.65
601 to 900mm	95.36	97.62	99.88	102.14	104.41	106.67	108.93	111.19	113.45
901 to 1200mm	107.96	110.22	112.48	114.74	117.01	119.27	121.53	123.79	126.05
1201 to 1500mm	145.75	148.80	151.85	154.91	157.96	161.01	164.06	167.12	170.17

2mm ALUMINIUM MILL FINISH 5005 GRADE - SHEET BUY IN**BENDS**

GIRTH	FLAT	1	2	3	4	5	6	7	8
up to 200mm	29.95	32.78	35.60	38.43	41.26	44.08	46.91	49.74	52.56
201 to 400mm	50.95	53.78	56.60	59.43	62.26	65.08	67.91	70.74	73.56
401 to 600mm	71.95	74.78	77.60	80.43	83.26	86.08	88.91	91.74	94.56
601 to 900mm	119.20	122.03	124.85	127.68	130.51	133.33	136.16	138.99	141.81
901 to 1200mm	134.95	137.78	140.60	143.43	146.26	149.08	151.91	154.74	157.56
1201 to 1500mm	182.18	186.00	189.82	193.63	197.45	201.26	205.08	208.90	212.71

3mm ALUMINIUM MILL FINISH 5005 GRADE - SHEET BUY IN**BENDS**

GIRTH	FLAT	1	2	3	4	5	6	7	8
up to 200mm	44.93	49.17	53.41	57.65	61.89	66.13	70.37	74.61	78.85
201 to 400mm	76.43	80.67	84.91	89.15	93.39	97.63	101.87	106.11	110.35
401 to 600mm	107.93	112.17	116.41	120.65	124.89	129.13	133.37	137.61	141.85
601 to 900mm	178.80	183.04	187.28	191.52	195.76	200.00	204.24	208.48	212.72
901 to 1200mm	202.43	206.67	210.91	215.15	219.39	223.63	227.87	232.11	236.35
1201 to 1500mm	273.28	279.00	284.72	290.45	296.17	301.90	307.62	313.34	319.07

GST Exclusive # 1 metre minimum charge per flashing # Squash Fold 1mm Only # Valid from August 2023

Commercial Gutter Range

6 Metre Smooth Rolled Range

Half Round Gutter

OG Style Gutter (Recommended 4 metre maximum)

Quad Style Gutter

8 Metre Folded Range

High Front Slotted

Low Front Unslotted

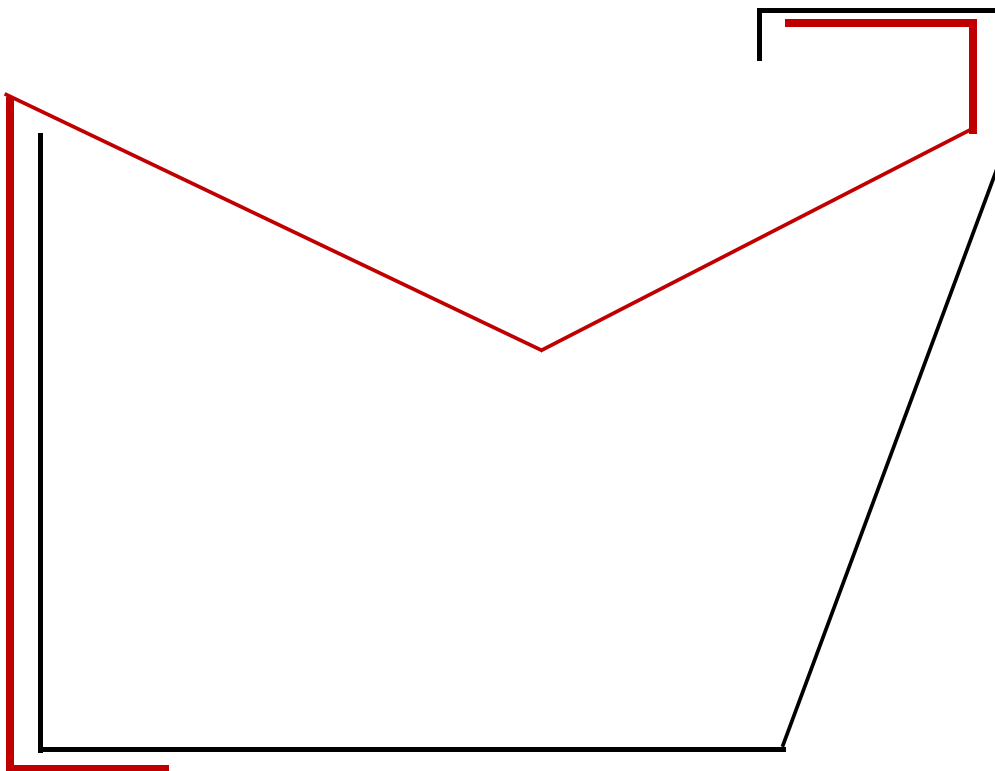

Gutter Range - Quick Info Guide

Half Round Gutter	Capacity (mm²)	.55 Std Colorbond - per lineal metre	Powder Coated Bracket to Suit	
150mm	7 300	\$18.47	\$24.30	3mm Aluminium
175mm	10 500	\$22.15	\$26.95	3mm Aluminium
200mm	13 700	\$23.03	\$29.77	3mm Aluminium
225mm	17 600	\$25.68	\$34.24	3mm Aluminium
250mm	22 000	\$29.88	\$37.39	3mm Aluminium
300mm	32 300	\$33.40	\$43.70	3mm Aluminium
350mm	44 600	\$36.92	\$61.34	3mm Aluminium
400mm	58 800	\$47.45	\$79.10	4mm Aluminium
450mm	75 000	\$56.23	\$91.39	4mm Aluminium
High Front Slotted Eaves Gutter	Capacity (mm²)	.55 Std Colorbond - per lineal metre	Concealed Bracket to Suit	
400 girth	10 500	\$22.58	\$9.73	3mm Galvabond
600 girth	27 500	\$27.83	\$11.07	3mm Galvabond
800 girth	42 500	\$36.06	\$18.50	4mm Duragal
1000 girth	65 000	\$42.75	\$24.62	5mm Duragal
1200 girth		\$45.77	\$34.83	6mm Duragal
* Pricing applies to the Standard Eaves Gutter Sizes				
Low Front Unslotted Eaves Gutter	Capacity (mm²)	.55 Std Colorbond - per lineal metre	Concealed Bracket to Suit	
400 girth	12 000	\$19.58	\$9.73	3mm Galvabond
600 girth	35 000	\$23.98	\$15.07	4mm Duragal
800 girth	60 000	\$32.21	\$21.35	5mm Duragal
1000 girth	70 000	\$38.90	\$29.62	6mm Duragal
1200 girth		\$41.93	\$34.83	6mm Duragal
* Pricing applies to the Standard Eaves Gutter Sizes				
OG Style - slotted	Capacity (mm²)	.55 Std Colorbond - per lineal metre	Concealed Bracket to Suit	
450 girth	12 000	\$32.88	\$9.73	3mm Galvabond
600 girth	22 550	\$36.40	\$11.07	3mm Galvabond
OG Style - unslotted	Capacity (mm²)	.55 Std Colorbond - per lineal metre	Concealed Bracket to Suit	
450 girth	16 500	\$29.88	\$9.73	3mm Galvabond
600 girth	28 700	\$33.40	\$11.07	3mm Galvabond

Half Round Gutters

Smooth Rolled Up to 6 metres length

Bead is 12mm Higher than Back of Gutter

Rolled Bead Front as Standard

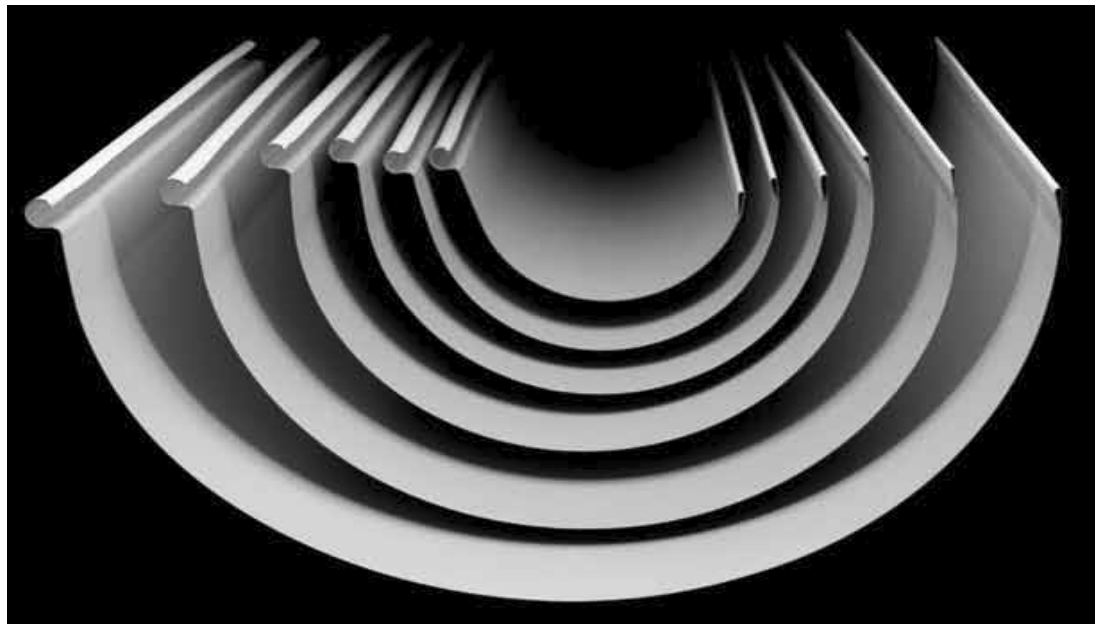

Gutter Capacity		Dimensions (mm)		
Gutter Diam	Effective Cross-Sectional Area (mm ²)	Front Height to Bead	Depth of Gutter	Height at Back of Gutter
150	7 300	87	75	75
175	10 500	101	89	89
200	13 700	112	100	100
225	17 600	124	112	112
250	22 000	137	125	125
300	32 300	162	150	150
350	44 600	187	175	175
400	58 800	212	200	200
450	75 000	237	225	225



Aluminium Powder Coated Laser Cut Brackets

Standard Lead time is 7 Working Days*

* Refer to Current Stock on hand / Otherwise 12 Working Days

Half Round Brackets - Information

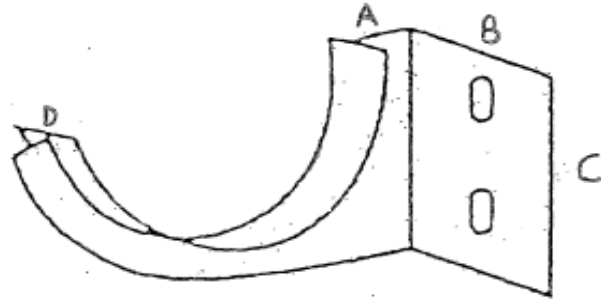
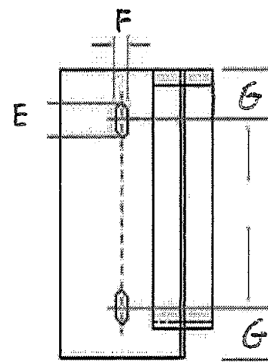
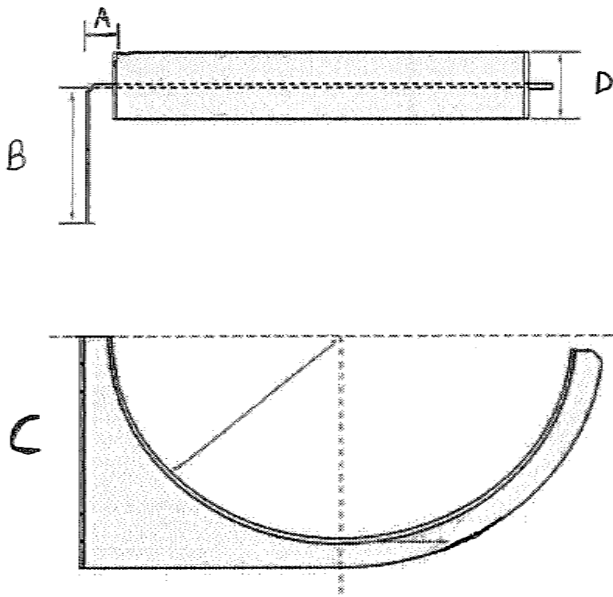

A Wall Stand Off
 B Width of Back Plate
 C Height of Back Plate

D Band Width
 E / F Slot Size
 G Slot Centre

		Bracket Dimensions (mm)					
Gutter Diam	Gutter Depth	A	B	C	D	E/F	G
150mm	75mm	14	80	95	25	20 x 8	30
175mm	88mm	14	80	107	40	20 x 8	30
200mm	100mm	14	80	120	40	20 x 8	30
225mm	113mm	14	80	133	40	20 x 8	30
250mm	125mm	14	80	145	40	20 x 8	30
300mm	150mm	14	80	170	40	20 x 8	30
350mm	175mm	14	80	200	40	20 x 8	40
400mm	200mm	24	100	228	40	25 x 12	40
450mm	225mm	24	100	253	40	25 x 12	40

		Bracket Thickness		
Gutter Diam	Aluminium	Stainless Steel	Galvabond	
150mm	3mm	2mm	2mm	
175mm	3mm	2mm	2mm	
200mm	3mm	2mm	2mm	
225mm	3mm	2mm	2mm	
250mm	3mm	2mm	2mm	
300mm	3mm	2mm	2mm	
350mm	3mm	2mm	2mm	
400mm	4mm	3mm	3mm	
450mm	4mm	3mm	3mm	

Half Round Brackets - Information

Stand Off From Wall - Top View of Bracket

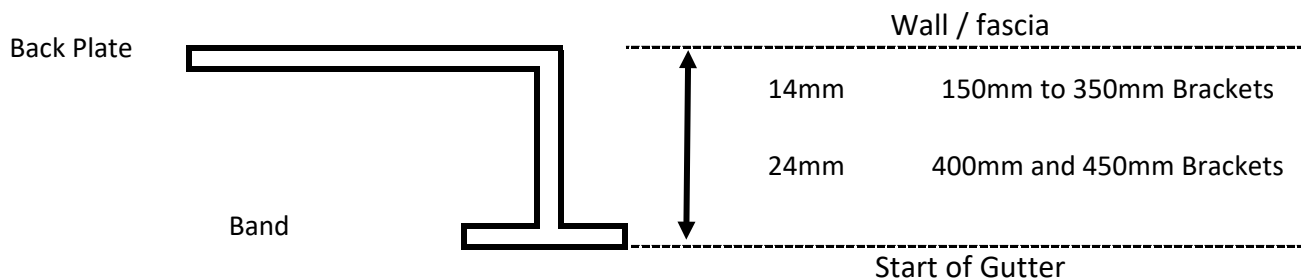

Standard Bracket Lead Times - Working Days

Gutter Diam	Aluminium	Stainless Steel	Galvabond
150mm	7	7	12
175mm	7	12	12
200mm	7	7	12
225mm	7	12	12
250mm	7	7	12
300mm	7	7	12
350mm	7	12	12
400mm	7	12	12
450mm	7	12	12

Standard Bracket Parts we Usually Stock

Gutter Diam	Aluminium	Stainless Steel	Galvabond
150mm	500 +	100	Nil
175mm	500 +	nil	Nil
200mm	500 +	100	Nil
225mm	500 +	nil	Nil
250mm	500 +	100	Nil
300mm	500 +	100	Nil
350mm	250	nil	Nil
400mm	150	nil	Nil
450mm	100	nil	Nil

Non - Standard Bracket - Pitched Brackets

Lead time is 12 - 15 working days (3 weeks)

Half Round Brackets - Information

New Style Brackets - Hook at Back / Gutter Stopper

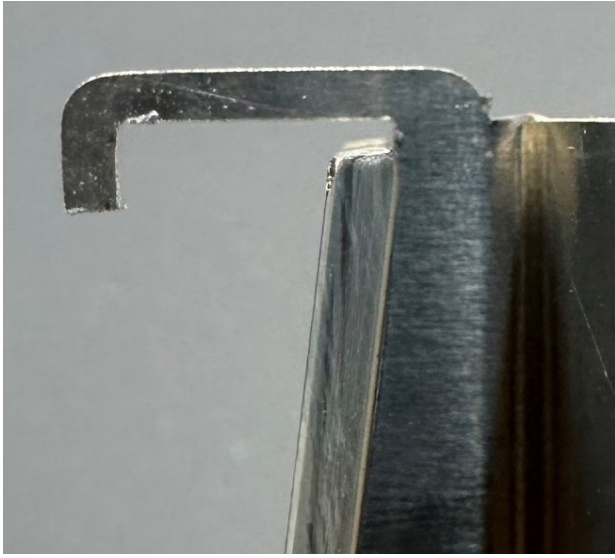

Now Available for Sizes 150mm to 350mm

Starter Stock - 500 off Each Size

Ask for Half Round Bracket with Hook when
Ordering

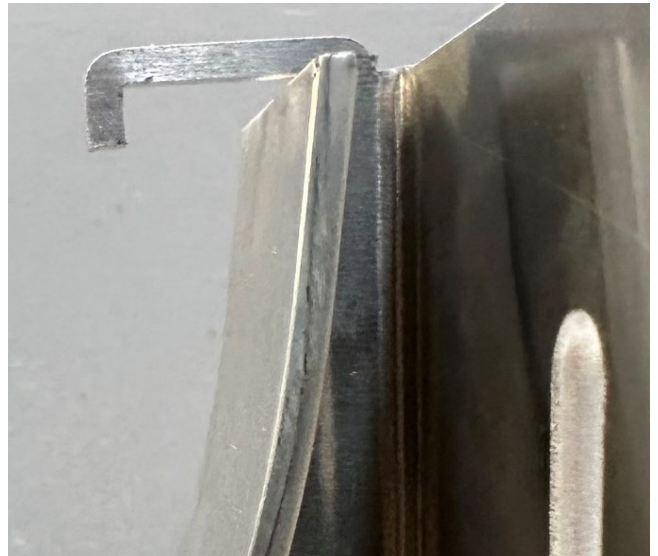

Half Round Gutters

Smooth Rolled Up to 6 metres length

Rolled Bead Front as Standard

Squash Fold at back

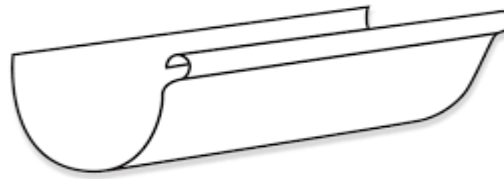

.55mm Material - Price per lineal Metre

Diam	C/bond	Zinc	Gal	Ultra	Metallic	304 2b	316 2b	Matt	
150mm	\$18.47	\$18.24	\$18.79	\$23.43	\$27.41	\$34.21	\$39.77	\$21.91	
175mm	\$22.15	\$21.57	\$22.30	\$28.42	\$33.67	\$42.65	\$49.98	\$26.41	
200mm	\$23.03	\$22.45	\$23.18	\$29.31	\$34.55	\$43.53	\$50.87	\$27.29	
225mm	\$25.68	\$24.22	\$24.95	\$31.07	\$36.32	\$45.30	\$52.63	\$29.06	
250mm	\$29.88	\$29.41	\$30.52	\$39.80	\$47.74	\$61.36	\$72.47	\$36.74	
300mm	\$33.40	\$31.18	\$32.29	\$41.57	\$49.51	\$63.12	\$74.23	\$38.51	
350mm	\$36.92	\$34.47	\$35.69	\$45.90	\$54.64	\$69.61	\$81.83	\$42.54	
400mm	\$47.45	\$44.12	\$45.78	\$59.70	\$71.62	\$92.03	\$108.70	\$55.12	
450mm	\$56.23	\$52.23	\$54.23	\$70.93	\$85.23	\$109.73	\$129.73	\$65.43	



Laser Cut Brackets

Diam	Aluminium + Powder Coated					Stainless		Uncoated	
	C/bond	Zinc	Ultra	Metallic	Matt	304 2b	316 2b	Gal	Ali
150mm	\$24.30	\$26.30	\$24.30	\$29.30	\$24.30	\$38.36	\$45.56	\$26.30	\$19.50
175mm	\$26.95	\$28.95	\$26.95	\$31.95	\$26.95	\$42.22	\$50.44	\$28.95	\$21.55
200mm	\$29.77	\$31.77	\$29.77	\$34.77	\$29.77	\$47.12	\$56.76	\$31.77	\$23.37
225mm	\$34.24	\$36.24	\$34.24	\$39.24	\$34.24	\$54.16	\$65.73	\$36.24	\$27.74
250mm	\$37.39	\$39.39	\$37.39	\$42.39	\$37.39	\$60.06	\$73.23	\$39.39	\$29.89
300mm	\$43.70	\$45.70	\$43.70	\$48.70	\$43.70	\$70.01	\$85.67	\$45.70	\$35.20
350mm	\$61.34	\$63.34	\$61.34	\$66.34	\$61.34	\$84.96	\$104.50	\$63.34	\$49.84
400mm	\$79.10	\$81.10	\$79.10	\$84.10	\$79.10	\$115.26	\$142.88	\$81.10	\$66.10
450mm	\$91.39	\$93.39	\$91.39	\$96.39	\$91.39	\$144.94	\$179.99	\$93.39	\$76.39

Brackets - Small Order Powder Coating Surcharge	\$50.00
--	----------------

Diam	150mm to 225mm	Orders less than 15 Brackets
Diam	250mm to 300mm	Orders less than 12 Brackets
Diam	350mm to 450mm	Orders less than 8 brackets

Standard Lead Times

Gutter & Accessories
Brackets

2 Working days
7 Working days (1.5 week)

Half Round Gutters

Corners - .55mm Material - Price per each

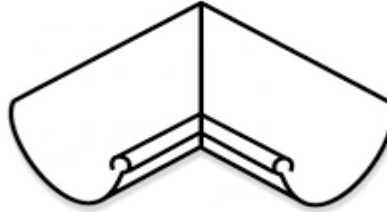

Diam	C/bond	Zinc	Gal	Ultra	Metallic	304 2b	316 2b	Matt	
150mm	\$71.47	\$71.24	\$71.79	\$76.43	\$80.41	\$87.21	\$92.77	\$74.91	
175mm	\$78.15	\$77.57	\$78.30	\$84.42	\$89.67	\$98.65	\$105.98	\$82.41	
200mm	\$81.03	\$80.45	\$81.18	\$87.31	\$92.55	\$101.53	\$108.87	\$85.29	
225mm	\$86.68	\$85.22	\$85.95	\$92.07	\$97.32	\$106.30	\$113.63	\$90.06	
250mm	\$93.88	\$93.41	\$94.52	\$103.80	\$111.74	\$125.36	\$136.47	\$100.74	
300mm	\$103.40	\$101.18	\$102.29	\$111.57	\$119.51	\$133.12	\$144.23	\$108.51	
350mm	\$111.92	\$109.47	\$110.69	\$120.90	\$129.64	\$144.61	\$156.83	\$117.54	
400mm	\$128.45	\$125.12	\$126.78	\$140.70	\$152.62	\$173.03	\$189.70	\$136.12	
450mm	\$142.23	\$138.23	\$140.23	\$156.93	\$171.23	\$195.73	\$215.73	\$151.43	

Stop Ends - .55mm Material - Price per each



Diam	C/bond	Zinc	Gal	Ultra	Metallic	304 2b	316 2b	Matt	
150mm	\$19.42	\$19.19	\$19.31	\$20.23	\$21.03	\$22.39	\$23.50	\$19.93	
175mm	\$21.18	\$20.96	\$21.07	\$22.00	\$22.79	\$24.16	\$25.27	\$21.69	
200mm	\$22.95	\$22.73	\$22.84	\$23.77	\$24.56	\$25.92	\$27.03	\$23.46	
225mm	\$25.42	\$25.11	\$25.26	\$26.56	\$27.67	\$29.58	\$31.13	\$26.13	
250mm	\$27.53	\$27.18	\$27.36	\$28.84	\$30.11	\$32.29	\$34.07	\$28.35	
300mm	\$31.77	\$31.32	\$31.54	\$33.40	\$34.99	\$37.71	\$39.93	\$32.79	
350mm	\$37.05	\$36.38	\$36.72	\$39.50	\$41.88	\$45.97	\$49.30	\$38.58	
400mm	\$42.33	\$41.44	\$41.89	\$45.60	\$48.78	\$54.22	\$58.67	\$44.38	
450mm	\$44.08	\$42.97	\$43.53	\$48.17	\$52.14	\$58.94	\$64.50	\$46.64	

Sculptured drop to suit - .55mm Material - price per each



Diam	C/bond	Zinc	Gal	Ultra	Metallic	304 2b	316 2b	Matt	
90mm	\$22.95	\$22.73	\$22.84	\$23.77	\$24.56	\$25.92	\$27.03	\$23.46	
100mm	\$26.48	\$26.26	\$26.37	\$27.30	\$28.09	\$29.46	\$30.57	\$26.99	
125mm	\$29.30	\$28.94	\$29.12	\$30.61	\$31.88	\$34.06	\$35.83	\$30.12	
150mm	\$31.07	\$30.71	\$30.89	\$32.37	\$33.64	\$35.82	\$37.60	\$31.88	
225mm	\$35.30	\$34.86	\$35.08	\$36.93	\$38.52	\$41.24	\$43.47	\$36.32	
300mm	\$40.58	\$39.92	\$40.25	\$43.03	\$45.42	\$49.50	\$52.83	\$42.12	

Half Round Flat Back Gutters

Smooth Rolled Up to 6 metres length

Rolled Bead Front as Standard

Half Round Flat Back Gutter

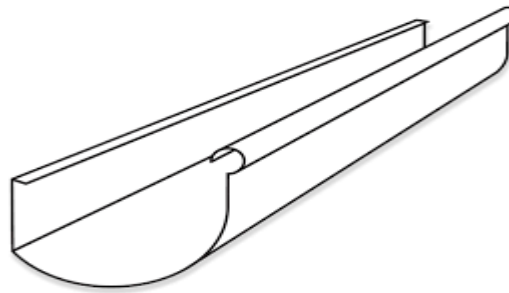

.55mm Material - Price per lineal Metre

Diam	C/bond	Zinc	Gal	Ultra	Metallic	304 2b	316 2b	Matt	
150mm	\$18.47	\$18.24	\$18.79	\$23.43	\$27.41	\$34.21	\$39.77	\$21.91	
175mm	\$22.15	\$21.57	\$22.30	\$28.42	\$33.67	\$42.65	\$49.98	\$26.41	
200mm	\$23.03	\$22.45	\$23.18	\$29.31	\$34.55	\$43.53	\$50.87	\$27.29	
225mm	\$25.68	\$24.22	\$24.95	\$31.07	\$36.32	\$45.30	\$52.63	\$29.06	
250mm	\$29.88	\$29.41	\$30.52	\$39.80	\$47.74	\$61.36	\$72.47	\$36.74	
300mm	\$33.40	\$31.18	\$32.29	\$41.57	\$49.51	\$63.12	\$74.23	\$38.51	
350mm	\$36.92	\$34.47	\$35.69	\$45.90	\$54.64	\$69.61	\$81.83	\$42.54	
400mm	\$47.45	\$44.12	\$45.78	\$59.70	\$71.62	\$92.03	\$108.70	\$55.12	
450mm	\$56.23	\$52.23	\$54.23	\$70.93	\$85.23	\$109.73	\$129.73	\$65.43	

Laser Cut A4 Style Brackets

Diam	Powder Coated		Plain	Powder Coated		Stainless Steel		P/C	Plain
	C/bond	Zinc	Gal	Ultra	Metallic	304 2b	316 2b	Matt	Ali
150mm	\$24.30	\$26.30	\$26.30	\$24.30	\$29.30	\$38.36	\$45.56	\$24.30	\$19.50
175mm	\$26.95	\$28.95	\$28.95	\$26.95	\$31.95	\$42.22	\$50.44	\$26.95	\$21.55
200mm	\$29.77	\$31.77	\$31.77	\$29.77	\$34.77	\$47.12	\$56.76	\$29.77	\$23.37
225mm	\$34.24	\$36.24	\$36.24	\$34.24	\$39.24	\$54.16	\$65.73	\$34.24	\$27.74
250mm	\$37.39	\$39.39	\$39.39	\$37.39	\$42.39	\$60.06	\$73.23	\$37.39	\$29.89
300mm	\$43.70	\$45.70	\$45.70	\$43.70	\$48.70	\$70.01	\$85.67	\$43.70	\$35.20
350mm	\$61.34	\$63.34	\$63.34	\$61.34	\$66.34	\$84.96	\$104.50	\$61.34	\$49.84
400mm	\$79.10	\$81.10	\$81.10	\$79.10	\$84.10	\$115.26	\$142.88	\$79.10	\$66.10
450mm	\$91.39	\$93.39	\$93.39	\$91.39	\$96.39	\$144.94	\$179.99	\$91.39	\$76.39

Bracket Lead time

150mm

7 Working Days

All Other Sizes

12 Working Days

Flat Back Half Round Gutters

Corners - .55mm Material - Price per each

Diam	C/bond	Zinc	Gal	Ultra	Metallic	304 2b	316 2b	Matt	
150mm	\$71.47	\$71.24	\$71.79	\$76.43	\$80.41	\$87.21	\$92.77	\$74.91	
175mm	\$78.15	\$77.57	\$78.30	\$84.42	\$89.67	\$98.65	\$105.98	\$82.41	
200mm	\$81.03	\$80.45	\$81.18	\$87.31	\$92.55	\$101.53	\$108.87	\$85.29	
225mm	\$86.68	\$85.22	\$85.95	\$92.07	\$97.32	\$106.30	\$113.63	\$90.06	
250mm	\$93.88	\$93.41	\$94.52	\$103.80	\$111.74	\$125.36	\$136.47	\$100.74	
300mm	\$103.40	\$101.18	\$102.29	\$111.57	\$119.51	\$133.12	\$144.23	\$108.51	
350mm	\$111.92	\$109.47	\$110.69	\$120.90	\$129.64	\$144.61	\$156.83	\$117.54	
400mm	\$128.45	\$125.12	\$126.78	\$140.70	\$152.62	\$173.03	\$189.70	\$136.12	
450mm	\$142.23	\$138.23	\$140.23	\$156.93	\$171.23	\$195.73	\$215.73	\$151.43	

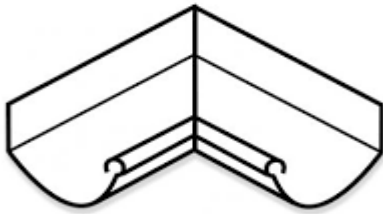

Stop Ends - .55mm Material - Price per each

Diam	C/bond	Zinc	Gal	Ultra	Metallic	304 2b	316 2b	Matt	
150mm	\$19.42	\$19.19	\$19.31	\$20.23	\$21.03	\$22.39	\$23.50	\$19.93	
175mm	\$21.18	\$20.96	\$21.07	\$22.00	\$22.79	\$24.16	\$25.27	\$21.69	
200mm	\$22.95	\$22.73	\$22.84	\$23.77	\$24.56	\$25.92	\$27.03	\$23.46	
225mm	\$25.42	\$25.11	\$25.26	\$26.56	\$27.67	\$29.58	\$31.13	\$26.13	
250mm	\$27.53	\$27.18	\$27.36	\$28.84	\$30.11	\$32.29	\$34.07	\$28.35	
300mm	\$31.77	\$31.32	\$31.54	\$33.40	\$34.99	\$37.71	\$39.93	\$32.79	
350mm	\$37.05	\$36.38	\$36.72	\$39.50	\$41.88	\$45.97	\$49.30	\$38.58	
400mm	\$42.33	\$41.44	\$41.89	\$45.60	\$48.78	\$54.22	\$58.67	\$44.38	
450mm	\$44.08	\$42.97	\$43.53	\$48.17	\$52.14	\$58.94	\$64.50	\$46.64	

Sculptured drop to suit - .55mm Material - price per each

Diam	C/bond	Zinc	Gal	Ultra	Metallic	304 2b	316 2b	Matt	
90mm	\$22.95	\$22.73	\$22.84	\$23.77	\$24.56	\$25.92	\$27.03	\$23.46	
100mm	\$26.48	\$26.26	\$26.37	\$27.30	\$28.09	\$29.46	\$30.57	\$26.99	
125mm	\$29.30	\$28.94	\$29.12	\$30.61	\$31.88	\$34.06	\$35.83	\$30.12	
150mm	\$31.07	\$30.71	\$30.89	\$32.37	\$33.64	\$35.82	\$37.60	\$31.88	
225mm	\$35.30	\$34.86	\$35.08	\$36.93	\$38.52	\$41.24	\$43.47	\$36.32	
300mm	\$40.58	\$39.92	\$40.25	\$43.03	\$45.42	\$49.50	\$52.83	\$42.12	

Eaves Gutter Library - First Edition

Almost 100 gutters included

Every Gutter has been supplied as a job previously

All Gutters use a Concealed Bracket

From Order to Site Delivery 24 to 48 hours

Bracket Material options 3mm Galvabond

4mm Duragal

5mm Duragal

6mm Duragal** Subject to lead times

We have a drawn to scale version of every gutter if detailed drawings are required

Can't find a design to use - ask for a Custom Design

CONTENTS

Gutters up to 400mm Girth	Page 2
Gutters from 401mm to 600mm Girth	Page 4
Gutters from 601mm to 800mm Girth	Page 15
Gutters from 801mm to 1000mm Girth	Page 20
Material Information	Page 23

Request a Copy of Our Gutter Catalogue as Above

COMMERCIAL EAVES GUTTER BRACKETS

CONCEALED BRACKET OPTION



Up to 600mm Girth options include:

40mm x 3mm Galvabond

50mm x 4mm Duragal

40mm x 3mm 304 or 316 Stainless Steel

Up to 1200mm Girth options include:

50mm x 4mm, 5mm or 6mm Duragal

50mm x 5mm 304 or 316 Stainless Steel

Standard Lead Time is 2 Working Days

Next Day Availability on request

EXTERNAL BRACKET OPTION



Up to 600mm Girth options include:

40mm x 3mm Galvabond

50mm x 4mm Duragal

40mm x 3mm 304 or 316 Stainless Steel

Up to 1200mm Girth options include:

50mm x 4mm, 5mm or 6mm Duragal

50mm x 5mm 304 or 316 Stainless Steel

Standard Lead Time is 7 Working Days for Powder Coated Brackets

Expedited Availability on request

Ask for our Commercial Eaves Gutter Catalogue -
Over 100 Gutters Ranging from 400mm to 1200mm Girth.

All

Capable of using Concealed Brackets. All have been supplied to previous Jobs ##

Duragal Flat Bar Bracket - Commercial Eaves Gutters

Eaves Gutter Girth - Usual Bracket Thickness Used

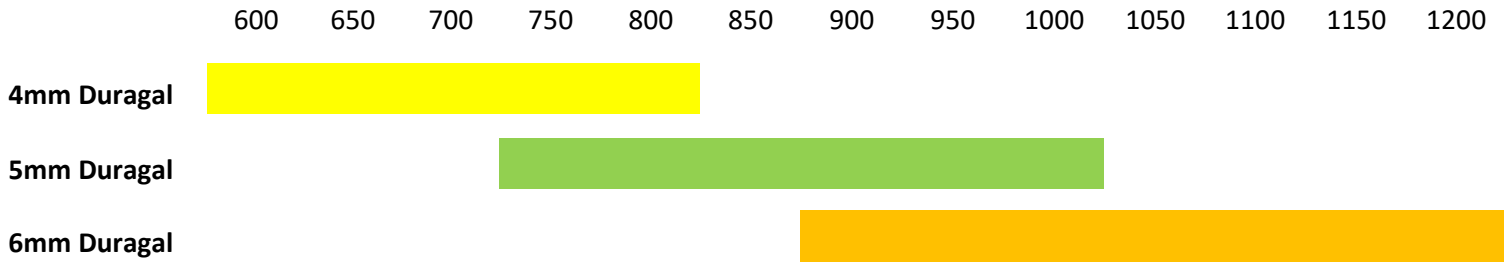

Bracket thickness selected depends on many factors including Gutter Style, Capacity and Bracket Spacing

Duragal Manufactured in Australia

Stock on Hand as at 20th May 2020

4mm Duragal	1200 Brackets
5mm Duragal	1500 Brackets
6mm Duragal	1200 Brackets

Approx Quantity above based on average gutter size selected

Lead Time to Site

	Concealed Bracket	External Powder Coated Bracket*
4mm Duragal	2 -3 Working days	1 week
5mm Duragal	2 -3 Working days	1.5 weeks
6mm Duragal	2 - 3 Working Days	1.5 weeks

*** Coated by Dulux Approved Applicator and follows correct cleaning, chemical pre treatment, coating and curing process required for Duragal Flat Bar**

How to Reduce Lead Time

Pre Order Brackets which can be held at CSM, then Gutter and Accessories Lead Time is 2 Working Days

Project Needs

If you have upcoming Job needs - advise and we can hold stock or order additional

This Stock Form is Updated and Available Monthly - Request to be added to Email List

COMMERCIAL HIGH FRONT SLOTTED EAVES GUTTERS

All have 85mm x 10mm slots @ 200mm centres

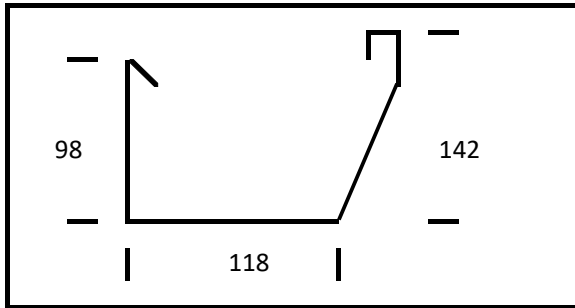

Concealed Bracket to Suit

40mm x 3mm Galvabond

Lead Time - 2 Working Days

400 High Front - Capacity 10 500

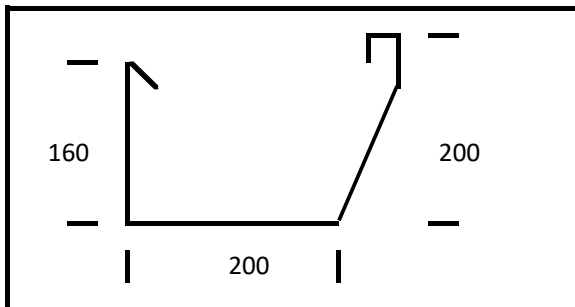

Concealed Bracket to Suit

40mm x 3mm Galvabond

Lead Time - 2 Working Days

600 High Front - Capacity 27 500

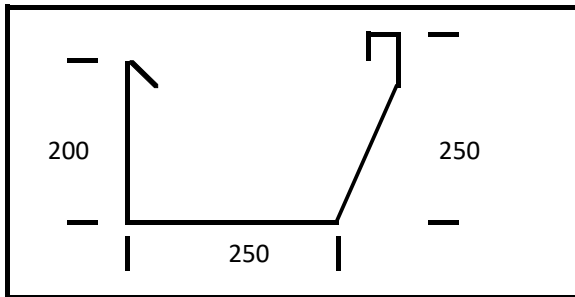

Concealed Bracket to Suit

50mm x 5mm Duragal

Lead Time - 2 Working Days

800 High Front - Capacity 42 500

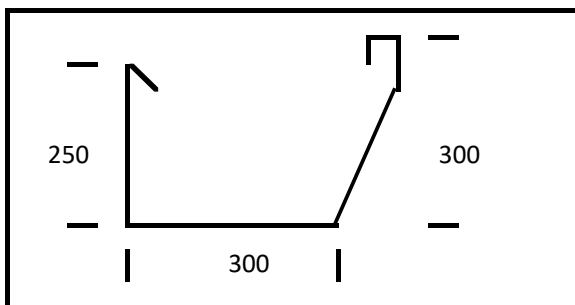

Concealed Bracket to Suit

50mm x 5mm Duragal

Lead Time - 2 Working Days

1000 High Front - Capacity 65 000

Commercial High Front Slotted Eaves Gutter

Slotted @ 200mm centres - 85mm x 10mm

.55mm Gutter - Price per lineal Metre

Gutter Size	C/bond	Zinc	Gal	Ultra	Metallic	304 2b	316 2b	Matt	
400mm	\$22.58	\$20.52	\$22.25	\$28.74	\$34.30	N/A	N/A	\$26.60	
600mm	\$27.83	\$25.61	\$27.98	\$37.72	\$46.07	N/A	N/A	\$34.52	
800mm	\$36.06	\$32.79	\$34.87	\$57.94	\$72.53	N/A	N/A	\$52.32	
1000mm	\$42.75	\$38.04	\$45.19	\$64.67	\$81.36	N/A	N/A	\$58.26	
1200mm	\$45.77	\$41.33	\$45.19	\$64.67	\$81.36	N/A	N/A	\$58.26	

Concealed Bracket to Suit - Price per each

Gutter Size	40mm x 3mm Flat Bar			50mm x 4mm Flat Bar	50mm x 5mm Flat Bar			50mm x 6mm
	Galvabond	304 SS	316 SS	Duragal	Duragal	304 SS	316 SS	Duragal
400mm	\$9.73							
600mm	\$11.07	\$26.27	\$31.07	\$15.07				
800mm				\$18.50	\$21.35	\$64.63	\$75.43	
1000mm					\$24.62			\$29.62
1200mm								\$34.83

.55mm Stop End - Price per each

Gutter Size	C/bond	Zinc	Gal	Ultra	Metallic	304 2b	316 2b	Matt	
400mm	\$21.17	\$20.72	\$20.94	\$22.80	\$24.39	\$27.11	\$29.33	\$22.19	
600mm	\$26.45	\$25.78	\$26.12	\$28.90	\$31.28	\$35.37	\$38.70	\$27.98	
800mm	\$26.45	\$25.78	\$26.12	\$28.90	\$31.28	\$35.37	\$38.70	\$27.98	
1000mm	\$33.48	\$32.37	\$32.93	\$37.57	\$41.54	\$48.34	\$53.90	\$36.04	
1200mm	\$33.48	\$32.37	\$32.93	\$37.57	\$41.54	\$48.34	\$53.90	\$36.04	

Powder Coated External Bracket to Suit - Price per each

Gutter Size	40mm x 5mm Aluminium	40mm x 3mm Galvabond	50mm x 4mm Duragal	50mm x 5mm Duragal	50mm x 6mm
					Duragal
400mm	\$20.30	\$20.47			
600mm	\$22.80	\$21.80	\$27.07		
800mm			\$31.50	\$34.35	
1000mm				\$38.73	\$43.73
1200mm					\$53.07

Brackets - Small Order Powder Coating Surcharge if Under 7 Brackets

\$50.00

Stainless External Bracket to Suit - Price per each

Gutter Size	40mm x 3mm 304	40mm x 3mm 316	50mm x 5mm 304	50mm x 5mm 316
400mm	\$24.67	\$27.07		
600mm	\$33.47	\$37.07	\$49.63	\$56.83
800mm			\$63.23	\$72.83
1000mm				

COMMERCIAL EAVES GUTTER - Unslotted Low Front

Many Unslotted Versions Available - See separate gutter catalogue - almost 100 gutters

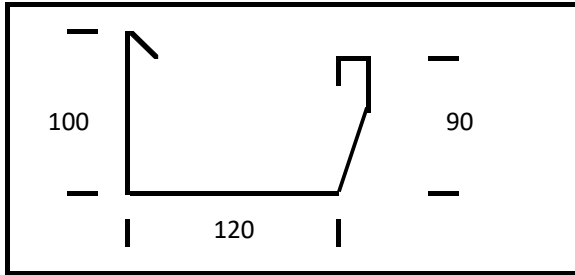

Concealed Bracket to Suit

40mm x 3mm Galvabond

Lead Time - 2 Working Days

400 Low Front - Capacity 12 000

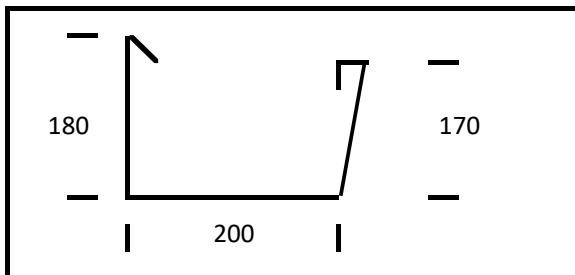

Concealed Bracket to Suit

40mm x 3mm Galvabond

Lead Time - 2 Working Days

600 Low Front - Capacity 35 000

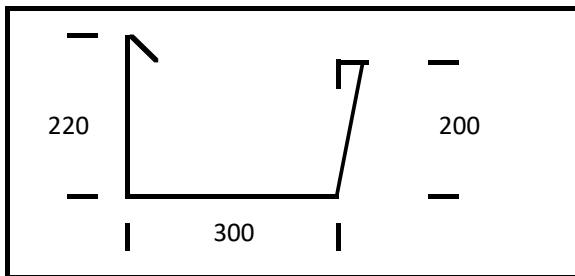

Concealed Bracket to Suit

50mm x 5mm Duragal

Lead Time - 2 Working Days

800 Low Front - Capacity 60 000

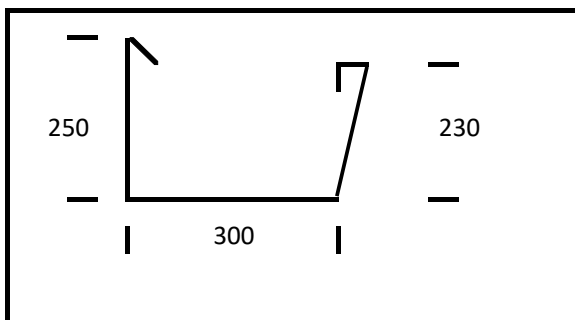

Concealed Bracket to Suit

50mm x 5mm Duragal

Lead Time - 2 Working Days

1000 Low Front - Capacity 70 000

OG Style Gutters

Smooth Rolled Up to 6 metres length

Slotted if Requested - 85mm x 10mm slot @ 500mm centres

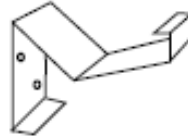
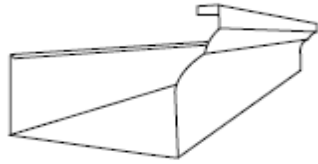

600mm Gutter	450mm Gutter

We Recommend a Maximum length of 4 Metres for OG Gutter, 6 metre length can be achieved but there will be a Visible Mark on the face from the finishing Process

Gutter Capacity

Gutter	Effective Cross-Sectional Area (mm ²)	
	Slotted	Unslotted
450	12000	16500
600	22550	28700

Concealed Brackets to Suit

Gutter	Bracket Material
450	40mm x 3mm Galvabond
600	40mm x 3mm Galvabond

Standard Lead Time is 3 Working Days

OG Gutters

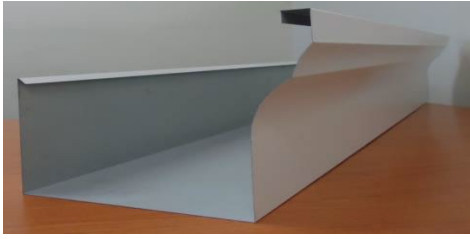

Up to 6 metre length

Can be Slotted - 85mm x 10mm
@ 500mm centres

We Recommend a Maximum length of 4 Metres for OG Gutter, 6 metre length can be achieved but there will be a Visible Mark on the face from the finishing Process

.55mm Material - Price per lineal Metre - Unslotted

Girth	C/bond	Zinc	Gal	Ultra	Metallic	304 2b	316 2b	Matt	
450mm	\$29.88	\$29.41	\$30.52	\$39.80	\$47.74	\$61.36	\$72.47	\$36.74	
600mm	\$33.40	\$31.18	\$32.29	\$41.57	\$49.51	\$63.12	\$74.23	\$38.51	
Extra for Slotting	\$4.00	\$4.00	\$4.00	\$4.00	\$4.00	N/A	N/A	\$4.00	



Concealed Brackets

40mm x 3mm Galvabond
40mm x 3mm 304 Stainless
40mm x 3mm 316 Stainless

\$11.07	each
\$26.27	each
\$31.07	each



Stop Ends

.55mm Material - Price per Stop End

	C/bond	Zinc	Gal	Ultra	Metallic	304 2b	316 2b	Matt	
All Sizes	\$26.45	\$25.78	\$26.12	\$28.90	\$31.28	\$35.37	\$38.70	\$27.98	



.55mm Material - Price per Corner (300mm x 300mm) - Unslotted

Girth	C/bond	Zinc	Gal	Ultra	Metallic	304 2b	316 2b	Matt	
450mm	\$119.77	\$118.82	\$121.04	\$139.60	\$155.49	\$182.71	\$204.93	\$133.49	
600mm	\$131.80	\$127.36	\$129.58	\$148.13	\$164.02	\$191.24	\$213.47	\$142.02	

Quad Gutters



Up to 6 metre length
Unslotted

Flat bar external bracket

Loose Stop End

.55mm Material - Price per lineal Metre

Gutter	C/bond	Zinc	Gal	Ultra	Metallic	304 2b	316 2b	Matt	
125mm	\$18.47	\$18.24	\$18.79	\$23.43	\$27.41	\$34.21	\$39.77	\$21.91	
150mm	\$22.15	\$21.57	\$22.30	\$28.42	\$33.67	\$42.65	\$49.98	\$26.41	
175mm	\$23.03	\$22.45	\$23.18	\$29.31	\$34.55	\$43.53	\$50.87	\$27.29	
200mm	\$25.68	\$24.22	\$24.95	\$31.07	\$36.32	\$45.30	\$52.63	\$29.06	
250mm	\$29.88	\$29.41	\$30.52	\$39.80	\$47.74	\$61.36	\$72.47	\$36.74	

Flat Bar External Bracket - price per each

	3mm Gal + P/Coat		Plain	3mm Gal + P/C			3mm Stainless		3mm Gal + P/Coat	
Gutter	C/bond	Zinc	Gal	Ultra	Metallic	304 2b	316 2b	Matt		
125mm	\$24.80	\$26.30	\$15.07	\$24.80	\$26.80	\$37.47	\$41.07	\$24.80		
150mm	\$25.80	\$27.30	\$16.07	\$25.80	\$27.80	\$38.47	\$42.07	\$25.80		
175mm	\$26.80	\$28.30	\$17.07	\$26.80	\$28.80	\$39.47	\$43.07	\$26.80		
200mm	\$27.80	\$29.30	\$18.07	\$27.80	\$29.80	\$40.47	\$44.07	\$27.80		
250mm	\$28.80	\$30.30	\$19.07	\$28.80	\$30.80	\$41.47	\$45.07	\$28.80		

Bracket Lead Time

7 Working Days

Stop End - price per each

Gutter	C/bond	Zinc	Gal	Ultra	Metallic	304 2b	316 2b	Matt	
125mm	\$22.95	\$22.73	\$22.84	\$23.77	\$24.56	\$25.92	\$27.03	\$23.46	
150mm	\$25.42	\$25.11	\$25.26	\$26.56	\$27.67	\$29.58	\$31.13	\$26.13	
175mm	\$27.53	\$27.18	\$27.36	\$28.84	\$30.11	\$32.29	\$34.07	\$28.35	
200mm	\$31.77	\$31.32	\$31.54	\$33.40	\$34.99	\$37.71	\$39.93	\$32.79	
250mm	\$37.05	\$36.38	\$36.72	\$39.50	\$41.88	\$45.97	\$49.30	\$38.58	

Corner - price per each

Gutter	C/bond	Zinc	Gal	Ultra	Metallic	304 2b	316 2b	Matt	
125mm	\$76.93	\$76.48	\$77.59	\$86.87	\$94.81	\$108.42	\$119.53	\$83.81	
150mm	\$84.30	\$83.13	\$84.60	\$96.85	\$107.33	\$125.30	\$139.97	\$92.81	
175mm	\$86.07	\$84.90	\$86.37	\$98.61	\$109.10	\$127.07	\$141.73	\$94.58	
200mm	\$91.37	\$88.43	\$89.90	\$102.15	\$112.63	\$130.60	\$145.27	\$98.11	
250mm	\$99.77	\$98.82	\$101.04	\$119.60	\$135.49	\$162.71	\$184.93	\$113.49	

Fabricated Items Cover Page

Next Day on Request - Pending Time of Order



Width

Gal Box Gutter Brackets

Fabricated to Size

- * 1.6mm Gal Channel for Base
- * 1mm Gal strap

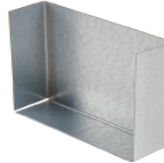
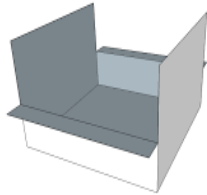
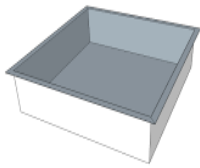

Standard 2 Working Day Lead Time

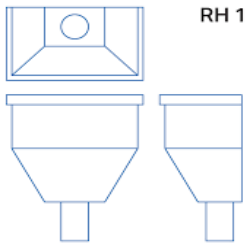

RH 1

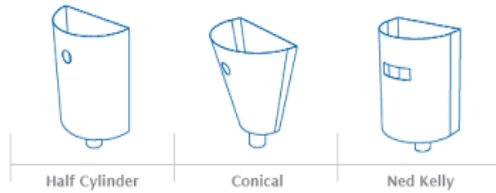

Half Cylinder

Conical

Ned Kelly

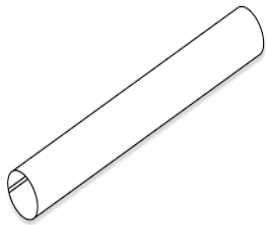
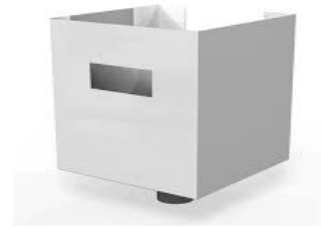

Round Downpipe to 6 metres

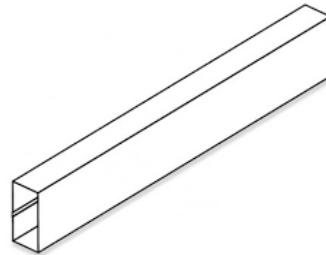

Rectangle Downpipe to 4 metres

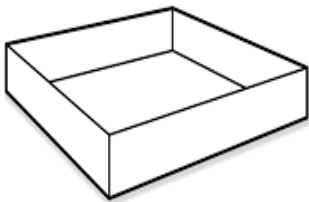

Longer Lead Times

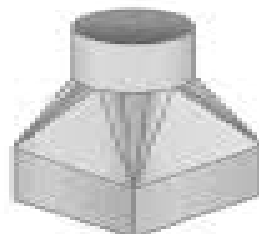

Light Gauge Fabricated Items - General Lead Time Guide

Item	Next Day Availability	48 Hour Availability	Other (Working Days)
Box Gutter Brackets	On Request	✓	
Stop Ends	On Request	✓	
Overflows	On Request	✓	
Chinaman Hats	X	✓	
Standard Sump	On Request	✓	
Tapered Bottom Sump	X	✓	
Sump with fitted drop	X	✓	
Hich Capacity Sump Units	X	✓	
Rainhead - Rectangle	On Request	✓	
Rainhead - Conical	On Request	✓	
Rainhead - Flat Bottom	On Request	✓	
Rainhead - Detailed design	X	X	3 -5 days
Round Downpipe - Straight	On Request	✓	
Round Downpipe Offset	X	✓	
Round Downpipe Elbow	X	✓	
T Bracket & Clip	On Request	✓	
Clip Only	On Request	✓	
Fabricated Drop	On Request	✓	
Rectangle Downpipe - Straight	On Request	✓	
Rectangle Downpipe Offset	X	✓	
Rectangle Downpipe Elbow	X	✓	
Rectangle Downpipe Clip	On Request	✓	
Rectangle Fabricated Drop	On Request	✓	
Fixed Metal Louvre	X	X	3 - 5 days
Ridge Vent	X	X	2 weeks
Window Hood	X	X	3 -5 days
Curves	X	On Request	3 days
Safe Trays	On Request	✓	
Spitters	On Request	✓	
Reducers / Transitions	X	✓	
Folded Downpipe Protectors	X	On Request	3 days
Circular Downpipe Protectors			
Hot Dip Galvanised	X	X	2 - 3 weeks
Pre Galvanised	X	X	1 week
Lockseam Flashings	X	✓	
## Next Day Availability - Occasionally Possible if Order Placed prior to 10am ##			

Working Days lead Time Guide

I have been given a Lead Time based on Working days but when will it be Ready?

The count starts on the day after order is placed

Example - Order Placed on Monday, **Day Number 1 is Tuesday**

Day Order Placed

Monday Tuesday Wednesday Thursday Friday

Order Due for Delivery

Working Days

1 - Next Day	Tuesday	Wednesday	Thursday	Friday	Monday
2	Wednesday	Thursday	Friday	Monday	Tuesday
3	Thursday	Friday	Monday	Tuesday	Wednesday
4	Friday	Monday	Tuesday	Wednesday	Thursday
5 - 1 week	Monday	Tuesday	Wednesday	Thursday	Friday
6	Tuesday	Wednesday	Thursday	Friday	Monday
7	Wednesday	Thursday	Friday	Monday	Tuesday
8	Thursday	Friday	Monday	Tuesday	Wednesday
9	Friday	Monday	Tuesday	Wednesday	Thursday
10 - 2 weeks	Monday	Tuesday	Wednesday	Thursday	Friday

Not Counted in Working days Lead Time

- Public Holidays
- Saturday
- Sunday
- Christmas Shutdown Period

Box Gutters & Accessories



Width

* 1.6mm Gal Channel for Base

* 1mm Gal strap

Gal Box Gutter Brackets - Fabricated to Size

Up to 400mm wide
 401mm to 600mm wide
 601mm to 800mm wide
 801mm to 1000mm wide
 1001mm to 1200mm wide
 1201mm to 1500mm wide

\$9.67	each
\$11.31	each
\$14.19	each
\$16.18	each
\$21.26	each
\$27.42	each



Gutter Board - 580mm cover x 6500mm Long

* Kept in stock

Per Length

\$112.00	each
----------	------

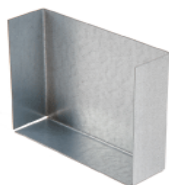

Stop Ends - Supplied Loose

.55mm Stop End - Price per each

Gutter Girth	C/bond	Zinc	Gal	Ultra	Metallic	304 2b	316 2b	Matt
400mm	\$21.17	\$20.72	\$20.94	\$22.80	\$24.39	\$27.11	\$29.33	\$22.19
600mm	\$26.45	\$25.78	\$26.12	\$28.90	\$31.28	\$35.37	\$38.70	\$27.98
800mm	\$26.45	\$25.78	\$26.12	\$28.90	\$31.28	\$35.37	\$38.70	\$27.98
1000mm	\$33.48	\$32.37	\$32.93	\$37.57	\$41.54	\$48.34	\$53.90	\$36.04
1200mm	\$33.48	\$32.37	\$32.93	\$37.57	\$41.54	\$48.34	\$53.90	\$36.04



Spitter

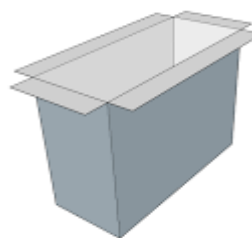

Fabricated Spitter - up to 400mm long

Size	C/bond	Zinc	Gal	Ultra	Metallic	304 2b	316 2b	Matt
75mm x 75mm	\$42.33	\$41.44	\$41.89	\$45.60	\$48.78	\$54.22	\$58.67	\$44.38
100mm x 75mm	\$42.33	\$41.44	\$41.89	\$45.60	\$48.78	\$54.22	\$58.67	\$44.38
100mm x 50mm	\$42.33	\$41.44	\$41.89	\$45.60	\$48.78	\$54.22	\$58.67	\$44.38
100mm x 100mm	\$42.33	\$41.44	\$41.89	\$45.60	\$48.78	\$54.22	\$58.67	\$44.38
100mm x 150mm	\$44.08	\$42.97	\$43.53	\$48.17	\$52.14	\$58.94	\$64.50	\$46.64
150mm x 150mm	\$44.08	\$42.97	\$43.53	\$48.17	\$52.14	\$58.94	\$64.50	\$46.64
200mm x 200mm	\$54.62	\$52.62	\$53.62	\$61.97	\$69.12	\$81.37	\$91.37	\$59.22
250mm x 250mm	\$56.37	\$54.14	\$55.26	\$64.53	\$72.48	\$86.09	\$97.20	\$61.48
300mm x 300mm	\$65.15	\$62.26	\$63.71	\$75.77	\$86.09	\$103.79	\$118.23	\$71.79

Box Gutters & Accessories

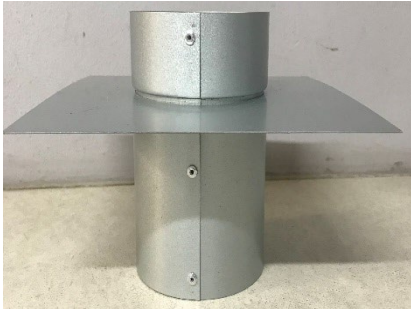

* Round Overflows

* Allowed up to 500mm Overall Height

.55mm Overflow - Price per each

Diam	C/bond	Zinc	Gal	Ultra	Metallic	304 2b	316 2b	Matt	
75mm	\$58.25	\$57.58	\$57.92	\$60.70	\$63.08	\$67.17	\$70.50	\$59.78	
90mm	\$58.25	\$57.58	\$57.92	\$60.70	\$63.08	\$67.17	\$70.50	\$59.78	
100mm	\$60.00	\$59.11	\$59.56	\$63.27	\$66.44	\$71.89	\$76.33	\$62.04	
125mm	\$69.71	\$68.71	\$69.21	\$73.38	\$76.96	\$83.08	\$88.08	\$72.01	
150mm	\$79.42	\$78.31	\$78.86	\$83.50	\$87.47	\$94.28	\$99.83	\$81.97	
225mm	\$104.08	\$102.08	\$103.08	\$111.43	\$118.58	\$130.83	\$140.83	\$108.68	
300mm	\$130.50	\$127.39	\$128.94	\$141.93	\$153.06	\$172.11	\$187.67	\$137.66	

* Round Overflows

* 501mm to 800mm Overall Height

.55mm Overflow - Price per each

Diam	C/bond	Zinc	Gal	Ultra	Metallic	304 2b	316 2b	Matt	
75mm	\$72.81	\$71.98	\$72.40	\$75.88	\$78.85	\$83.96	\$88.13	\$74.73	
90mm	\$72.81	\$71.98	\$72.40	\$75.88	\$78.85	\$83.96	\$88.13	\$74.73	
100mm	\$75.00	\$73.89	\$74.44	\$79.08	\$83.06	\$89.86	\$95.42	\$77.56	
125mm	\$87.14	\$85.89	\$86.51	\$91.73	\$96.20	\$103.85	\$110.10	\$90.01	
150mm	\$99.27	\$97.88	\$98.58	\$104.38	\$109.34	\$117.85	\$124.79	\$102.47	
225mm	\$130.10	\$127.60	\$128.85	\$139.29	\$148.23	\$163.54	\$176.04	\$135.85	
300mm	\$163.13	\$159.24	\$161.18	\$177.42	\$191.32	\$215.14	\$234.58	\$172.07	



* Chinaman Hats

* 3 legs riveted / spot welded

.55mm Chinaman Hat - Price per each

Diam	C/bond	Zinc	Gal	Ultra	Metallic	304 2b	316 2b	Matt	
75mm	\$58.25	\$57.58	\$57.92	\$60.70	\$63.08	\$67.17	\$70.50	\$59.78	
90mm	\$58.25	\$57.58	\$57.92	\$60.70	\$63.08	\$67.17	\$70.50	\$59.78	
100mm	\$60.00	\$59.11	\$59.56	\$63.27	\$66.44	\$71.89	\$76.33	\$62.04	
125mm	\$69.71	\$68.71	\$69.21	\$73.38	\$76.96	\$83.08	\$88.08	\$72.01	
150mm	\$79.42	\$78.31	\$78.86	\$83.50	\$87.47	\$94.28	\$99.83	\$81.97	
225mm	\$104.08	\$102.08	\$103.08	\$111.43	\$118.58	\$130.83	\$140.83	\$108.68	
300mm	\$130.50	\$127.39	\$128.94	\$141.93	\$153.06	\$172.11	\$187.67	\$137.66	

Sumps

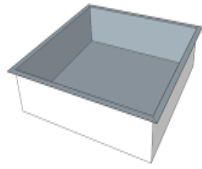

* Standard Flat Bottom Style

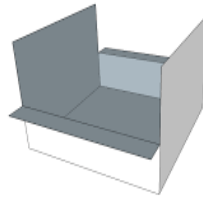

* Inline Style

* Stop End Style

.55mm Sump - Price per each

Size	C/bond	Zinc	Gal	Ultra	Metallic	304 2b	316 2b	Matt	
300mm Square	\$84.67	\$82.89	\$83.78	\$91.20	\$97.56	\$108.44	\$117.33	\$88.76	
400mm Square	\$88.17	\$85.94	\$87.06	\$96.33	\$104.28	\$117.89	\$129.00	\$93.28	
500mm Square	\$91.67	\$89.00	\$90.33	\$101.47	\$111.00	\$127.33	\$140.67	\$97.80	
600mm Square	\$96.92	\$93.58	\$95.25	\$109.17	\$121.08	\$141.50	\$158.17	\$104.58	
700mm Square	\$112.75	\$108.53	\$110.64	\$128.27	\$143.36	\$169.22	\$190.33	\$122.46	
800mm Square	\$126.83	\$121.94	\$124.39	\$144.80	\$162.28	\$192.22	\$216.67	\$138.08	
900mm Square	\$133.83	\$128.06	\$130.94	\$155.07	\$175.72	\$211.11	\$240.00	\$147.12	
1000mm Square	\$162.00	\$154.89	\$158.44	\$188.13	\$213.56	\$257.11	\$292.67	\$178.36	

Price Notes

- # When unequal sides - use the biggest side
- # Prices above cover up to 150mm Deep Sumps
- # If 151mm to 250mm Deep - go to next size up
- # If 251mm to 350mm Deep - go 2 sizes up



* Tapered Bottom Sumps

.55mm Material - Price per each

Size	C/bond	Zinc	Gal	Ultra	Metallic	304 2b	316 2b	Matt	
300mm Square	\$127.00	\$124.33	\$125.67	\$136.80	\$146.33	\$162.67	\$176.00	\$133.13	
400mm Square	\$132.25	\$128.92	\$130.58	\$144.50	\$156.42	\$176.83	\$193.50	\$139.92	
500mm Square	\$137.50	\$133.50	\$135.50	\$152.20	\$166.50	\$191.00	\$211.00	\$146.70	
600mm Square	\$145.38	\$140.38	\$142.88	\$163.75	\$181.63	\$212.25	\$237.25	\$156.88	
700mm Square	\$169.13	\$162.79	\$165.96	\$192.40	\$215.04	\$253.83	\$285.50	\$183.69	
800mm Square	\$190.25	\$182.92	\$186.58	\$217.20	\$243.42	\$288.33	\$325.00	\$207.12	
900mm Square	\$200.75	\$192.08	\$196.42	\$232.60	\$263.58	\$316.67	\$360.00	\$220.68	
1000mm Square	\$243.00	\$232.33	\$237.67	\$282.20	\$320.33	\$385.67	\$439.00	\$267.53	

Price Notes

- # When unequal sides - use the biggest side
- # Prices above cover up to 150mm Deep Sumps
- # If 151mm to 250mm Deep - go to next size up
- # If 251mm to 350mm Deep - go 2 sizes up

Option for Fitted Drop into Any Sump as Extra

	C/bond	Zinc	Gal	Ultra	Metallic	304 2b	316 2b	Matt	
100 or 150mm	\$56.50	\$56.06	\$56.28	\$58.13	\$59.72	\$62.44	\$64.67	\$57.52	
225mm	\$66.50	\$66.06	\$66.28	\$68.13	\$69.72	\$72.44	\$74.67	\$67.52	

High Capacity Sump Units

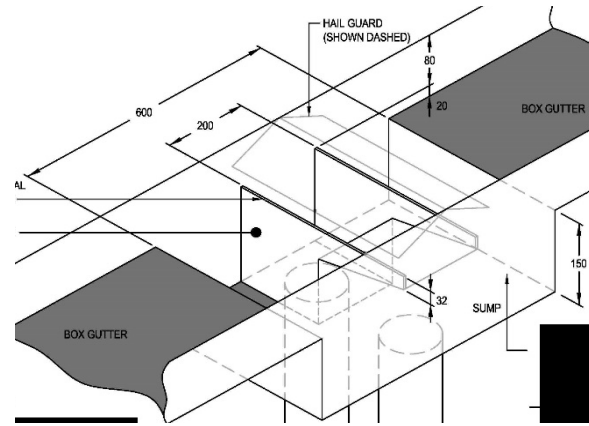
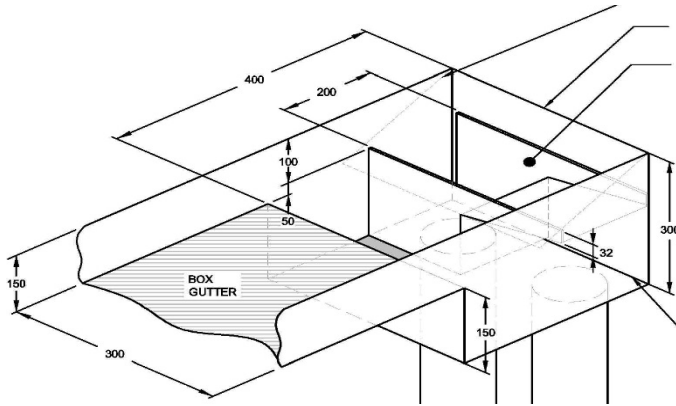

Included Per Unit - Fitted

Sump

Weir

2 x Drops

Price Per Unit With Up to 150mm diam drop - 2 off

Sump Size	C/bond	Zinc	Gal	Ultra	Metallic	304 2b	316 2b	Matt
400mm square	\$285.83	\$281.83	\$283.83	\$300.53	\$314.83	\$339.33	\$359.33	\$295.03
600mm square	\$298.08	\$292.53	\$295.31	\$318.50	\$338.36	\$372.39	\$400.17	\$310.86
800mm square	\$331.50	\$323.94	\$327.72	\$359.27	\$386.28	\$432.56	\$470.33	\$348.88
1000mm square	\$371.92	\$361.47	\$366.69	\$410.30	\$447.64	\$511.61	\$563.83	\$395.94

Price Per Unit With 2 x 225mm or 300mm diam drop

Sump Size	C/bond	Zinc	Gal	Ultra	Metallic	304 2b	316 2b	Matt
600mm square	\$318.08	\$311.64	\$314.86	\$341.77	\$364.81	\$404.28	\$436.50	\$332.91
800mm square	\$351.50	\$343.94	\$347.72	\$379.27	\$406.28	\$452.56	\$490.33	\$368.88
1000mm square	\$391.92	\$381.47	\$386.69	\$430.30	\$467.64	\$531.61	\$583.83	\$415.94

Option for Weir Supplied Loose

Sump Size	C/bond	Zinc	Gal	Ultra	Metallic	304 2b	316 2b	Matt
400mm square	\$84.67	\$82.89	\$83.78	\$91.20	\$97.56	\$108.44	\$117.33	\$88.76
600mm square	\$88.17	\$85.94	\$87.06	\$96.33	\$104.28	\$117.89	\$129.00	\$93.28
800mm square	\$91.67	\$89.00	\$90.33	\$101.47	\$111.00	\$127.33	\$140.67	\$97.80
1000mm square	\$96.92	\$93.58	\$95.25	\$109.17	\$121.08	\$141.50	\$158.17	\$104.58

All Other Loose components refer sump and drop pricing

Rainheads

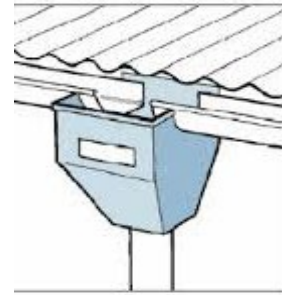
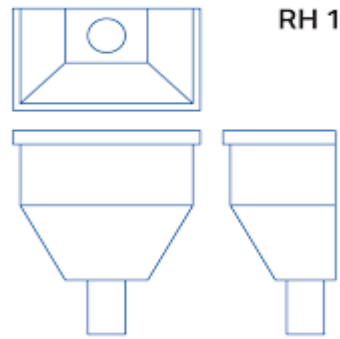

Rectangular Style Rainheads

.55mm Material - Price per Each

Width	C/bond	Zinc	Gal	Ultra	Metallic	304 2b	316 2b	Matt
300mm	\$254.17	\$251.06	\$252.61	\$265.60	\$276.72	\$295.78	\$311.33	\$261.32
400mm	\$261.17	\$257.17	\$259.17	\$275.87	\$290.17	\$314.67	\$334.67	\$270.37
500mm	\$289.33	\$284.00	\$286.67	\$308.93	\$328.00	\$360.67	\$387.33	\$301.60
600mm	\$296.33	\$290.11	\$293.22	\$319.20	\$341.44	\$379.56	\$410.67	\$310.64
750mm	\$324.50	\$316.94	\$320.72	\$352.27	\$379.28	\$425.56	\$463.33	\$341.88
900mm	\$352.67	\$343.78	\$348.22	\$385.33	\$417.11	\$471.56	\$516.00	\$373.11
1200mm	\$440.83	\$429.72	\$435.28	\$481.67	\$521.39	\$589.44	\$645.00	\$466.39

Price Notes

* Fitted Drop is included in Price

Conical Style Rainheads



.55mm Material - Price per Each

Width	C/bond	Zinc	Gal	Ultra	Metallic	304 2b	316 2b	Matt
300mm	\$236.50	\$233.39	\$234.94	\$247.93	\$259.06	\$278.11	\$293.67	\$243.66
400mm	\$243.50	\$239.50	\$241.50	\$258.20	\$272.50	\$297.00	\$317.00	\$252.70
500mm	\$271.67	\$266.33	\$269.00	\$291.27	\$310.33	\$343.00	\$369.67	\$283.93
600mm	\$278.67	\$272.44	\$275.56	\$301.53	\$323.78	\$361.89	\$393.00	\$292.98
750mm	\$306.83	\$299.28	\$303.06	\$334.60	\$361.61	\$407.89	\$445.67	\$324.21
900mm	\$335.00	\$326.11	\$330.56	\$367.67	\$399.44	\$453.89	\$498.33	\$355.44
1200mm	\$418.75	\$407.64	\$413.19	\$459.58	\$499.31	\$567.36	\$622.92	\$444.31

Price Notes

* Fitted Drop is included in Price

Option for Overflow Hole or Fitted Overflow - Extra

	C/bond	Zinc	Gal	Ultra	Metallic	304 2b	316 2b	Matt
Hole Cut Only	\$28.27	\$28.27	\$28.27	\$28.27	\$28.27	\$28.27	\$28.27	\$28.27
Fitted Overflow	\$56.50	\$56.06	\$56.28	\$58.13	\$59.72	\$62.44	\$64.67	\$57.52

Rainheads

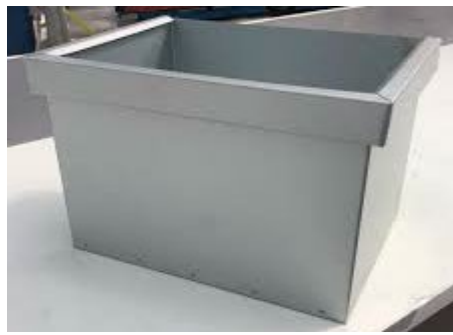

Flat Bottom Style Rainheads

.55mm Material - Price per Each

Width	C/bond	Zinc	Gal	Ultra	Metallic	304 2b	316 2b	Matt	
300mm	\$224.17	\$221.06	\$222.61	\$235.60	\$246.72	\$265.78	\$281.33	\$231.32	
400mm	\$231.17	\$227.17	\$229.17	\$245.87	\$260.17	\$284.67	\$304.67	\$240.37	
500mm	\$259.33	\$254.00	\$256.67	\$278.93	\$298.00	\$330.67	\$357.33	\$271.60	
600mm	\$266.33	\$260.11	\$263.22	\$289.20	\$311.44	\$349.56	\$380.67	\$280.64	
750mm	\$294.50	\$286.94	\$290.72	\$322.27	\$349.28	\$395.56	\$433.33	\$311.88	
900mm	\$322.67	\$313.78	\$318.22	\$355.33	\$387.11	\$441.56	\$486.00	\$343.11	
1200mm	\$403.33	\$392.22	\$397.78	\$444.17	\$483.89	\$551.94	\$607.50	\$428.89	

Price Notes

* Fitted Drop is included in Price

Option for Overflow Hole or Fitted Overflow - Extra

	C/bond	Zinc	Gal	Ultra	Metallic	304 2b	316 2b	Matt	
Hole Cut Only	\$28.27	\$28.27	\$28.27	\$28.27	\$28.27	\$28.27	\$28.27	\$28.27	
Fitted Overflow	\$56.50	\$56.06	\$56.28	\$58.13	\$59.72	\$62.44	\$64.67	\$57.52	

Leaf Eater Style Rainheads



Gal Mesh On top

Mozzie Mesh inside

.55mm Material - Price per Each

Suit Drop size	C/bond	Zinc	Gal	Ultra	Metallic	304 2b	316 2b	Matt	
100mm	\$296.33	\$290.11	\$293.22	\$319.20	\$341.44	\$379.56	\$410.67	\$310.64	
150mm	\$324.50	\$316.94	\$320.72	\$352.27	\$379.28	\$425.56	\$463.33	\$341.88	
225mm	\$352.67	\$343.78	\$348.22	\$385.33	\$417.11	\$471.56	\$516.00	\$373.11	
300mm	\$440.83	\$429.72	\$435.28	\$481.67	\$521.39	\$589.44	\$645.00	\$466.39	

Price Notes

* Fitted Drop is included in Price

Round Downpipe

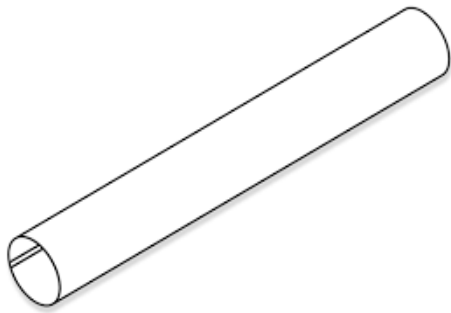

Up to 6 metre Lengths

75mm diam to 300mm diam

Riveted Bends to make offset

Tapered downpipe

T brackets & Clips Available

Downpipe is charged per metre with 1 metre minimum charge

Standard Pipe lead Time is 2 Working Days, offsets longer

.55mm Downpipe - Price per lineal Metre

Diam	Max	C/bond	Zinc	Gal	Ultra	Metallic	304 2b	316 2b	Matt
75mm	2.4 metre	\$24.63	\$23.30	\$25.73	\$31.30	\$36.07	\$44.23	\$50.90	\$29.47
90mm	Up to 6 metre length	\$25.68	\$24.22	\$26.72	\$32.84	\$38.08	\$47.07	\$54.40	\$30.82
100mm		\$26.38	\$24.83	\$27.37	\$33.87	\$39.43	\$48.96	\$56.73	\$31.73
125mm		\$33.40	\$31.18	\$34.06	\$43.33	\$51.28	\$64.89	\$76.00	\$40.28
150mm		\$33.40	\$31.18	\$34.06	\$43.33	\$51.28	\$64.89	\$76.00	\$38.51
225mm		\$46.57	\$43.23	\$45.78	\$60.58	\$72.50	\$92.92	\$109.58	\$56.00
300mm	2.4 metre	\$57.97	\$53.52	\$57.51	\$76.07	\$91.96	\$119.18	\$141.40	\$69.96

.55mm Material - Price Per Each Riveted Bend - Labour Only

Diam	75mm	90mm	100mm	125mm	150mm	225mm	300mm
C/bond, Zinc Gal	\$53.00	\$53.00	\$53.00	\$60.07	\$60.07	\$67.13	\$73.13
Stainless	\$60.07	\$60.07	\$60.07	\$67.13	\$67.13	\$72.13	\$78.13

Offset - Fabricated to Size



Pricing Notes

* Allow for the amount of pipe required at per metre rates from top of page

* Add Price for 2 x Riveted Bends as per below (or as many bends as required)

Round Downpipe

Adjustable Offset - .55mm Material - Price per unit

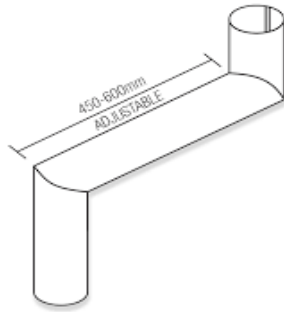

Diam	C/bond	Zinc	Gal	Ultra	Metallic	304 2b	316 2b	Matt
75mm	\$155.27	\$152.60	\$157.47	\$168.60	\$192.27	\$208.60	\$221.93	\$164.93
90mm	\$157.37	\$154.43	\$159.43	\$171.68	\$196.30	\$214.27	\$228.93	\$167.65
100mm	\$158.77	\$155.66	\$160.74	\$173.73	\$198.99	\$218.04	\$233.60	\$169.46
125mm	\$186.93	\$182.49	\$188.24	\$206.80	\$236.82	\$264.04	\$286.27	\$200.69
150mm	\$186.93	\$182.49	\$188.24	\$206.80	\$236.82	\$264.04	\$286.27	\$197.16
225mm	\$227.40	\$220.73	\$225.83	\$255.43	\$289.27	\$330.10	\$363.43	\$246.27
300mm	\$262.20	\$253.31	\$261.29	\$298.40	\$340.18	\$394.62	\$439.07	\$286.18

Riveted Elbow - 300mm x 300mm



.55mm Material - Price Per Elbow

Diam	C/bond	Zinc	Gal	Ultra	Metallic	304 2b	316 2b	Matt
75mm	\$77.63	\$76.30	\$78.73	\$84.30	\$96.13	\$104.30	\$110.97	\$82.47
90mm	\$78.68	\$77.22	\$79.72	\$85.84	\$98.15	\$107.13	\$114.47	\$83.82
100mm	\$79.38	\$77.83	\$80.37	\$86.87	\$99.49	\$109.02	\$116.80	\$84.73
125mm	\$93.47	\$91.24	\$94.12	\$103.40	\$118.41	\$132.02	\$143.13	\$100.34
150mm	\$93.47	\$91.24	\$94.12	\$103.40	\$118.41	\$132.02	\$143.13	\$98.58
225mm	\$113.70	\$110.37	\$112.92	\$127.72	\$144.63	\$165.05	\$181.72	\$123.13
300mm	\$131.10	\$126.66	\$130.64	\$149.20	\$170.09	\$197.31	\$219.53	\$143.09

Round Downpipe Accessories



T Bracket (.55mm) & Clip (.55mm) - price per set

Diam	C/bond	Zinc	Gal	Ultra	Metallic	304 2b	316 2b	Matt	
75mm	\$20.38	\$20.26	\$20.32	\$20.82	\$21.25	\$21.99	\$22.59	\$20.66	
90mm	\$21.26	\$21.14	\$21.20	\$21.71	\$22.14	\$22.87	\$23.48	\$21.54	
100mm	\$22.15	\$22.03	\$22.09	\$22.59	\$23.02	\$23.76	\$24.36	\$22.42	
125mm	\$24.28	\$24.11	\$24.20	\$24.89	\$25.49	\$26.51	\$27.34	\$24.66	
150mm	\$26.05	\$25.88	\$25.96	\$26.66	\$27.25	\$28.28	\$29.11	\$26.43	
225mm	\$31.93	\$31.69	\$31.81	\$32.81	\$33.67	\$35.15	\$36.35	\$32.48	
300mm	\$37.81	\$37.50	\$37.66	\$38.97	\$40.09	\$42.02	\$43.60	\$38.54	

T Bracket (3mm Gal - UNCOATED) & Clip (.55mm) - price per set

Diam	C/bond	Zinc	Gal	Ultra	Metallic	304 2b	316 2b	Matt	
75mm	\$30.52	\$30.44	\$30.48	\$30.83	\$31.13	\$36.60	\$37.02	\$30.71	
90mm	\$30.52	\$30.44	\$30.48	\$30.83	\$31.13	\$36.60	\$37.02	\$30.71	
100mm	\$30.52	\$30.44	\$30.48	\$30.83	\$31.13	\$36.60	\$37.02	\$30.71	
125mm	\$35.08	\$34.96	\$35.02	\$35.48	\$35.88	\$44.00	\$44.56	\$35.33	
150mm	\$35.08	\$34.96	\$35.02	\$35.48	\$35.88	\$44.00	\$44.56	\$35.33	
225mm	\$39.85	\$39.68	\$39.76	\$40.46	\$41.05	\$52.00	\$52.83	\$40.23	
300mm	\$44.62	\$44.39	\$44.51	\$45.43	\$46.23	\$60.00	\$61.11	\$45.13	

Clip Only Price - .55mm Material

Diam	C/bond	Zinc	Gal	Ultra	Metallic	304 2b	316 2b	Matt	
75mm	\$10.19	\$10.13	\$10.16	\$10.41	\$10.63	\$11.00	\$11.30	\$10.33	
90mm	\$10.63	\$10.57	\$10.60	\$10.85	\$11.07	\$11.44	\$11.74	\$10.77	
100mm	\$11.07	\$11.01	\$11.04	\$11.30	\$11.51	\$11.88	\$12.18	\$11.21	
125mm	\$12.14	\$12.06	\$12.10	\$12.45	\$12.74	\$13.25	\$13.67	\$12.33	
150mm	\$13.02	\$12.94	\$12.98	\$13.33	\$13.63	\$14.14	\$14.55	\$13.21	
225mm	\$15.96	\$15.84	\$15.90	\$16.41	\$16.84	\$17.57	\$18.18	\$16.24	
300mm	\$18.91	\$18.75	\$18.83	\$19.48	\$20.05	\$21.01	\$21.80	\$19.27	



Zincalume Stock Drops - Punched

90mm diam	
\$9.60	EACH

100mm diam	
\$9.60	EACH

150mm diam	
\$12.60	EACH

Round Downpipe Accessories



Fabricated Round Drop - up to 150mm long

Diam	C/bond	Zinc	Gal	Ultra	Metallic	304 2b	316 2b	Matt	
75mm	\$21.55	\$21.51	\$21.53	\$21.71	\$21.87	\$22.14	\$22.37	\$21.65	
90mm	\$21.90	\$21.81	\$21.86	\$22.23	\$22.54	\$23.09	\$23.53	\$22.10	
100mm	\$22.25	\$22.12	\$22.18	\$22.74	\$23.22	\$24.03	\$24.70	\$22.56	
125mm	\$22.60	\$22.42	\$22.51	\$23.25	\$23.89	\$24.98	\$25.87	\$23.01	
150mm	\$22.95	\$22.73	\$22.84	\$23.77	\$24.56	\$25.92	\$27.03	\$23.46	
225mm	\$27.53	\$27.18	\$27.36	\$28.84	\$30.11	\$32.29	\$34.07	\$28.35	
300mm	\$31.77	\$31.32	\$31.54	\$33.40	\$34.99	\$37.71	\$39.93	\$32.79	

Fabricated Round Drop - up to 500mm long

Diam	C/bond	Zinc	Gal	Ultra	Metallic	304 2b	316 2b	Matt	
75mm	\$32.33	\$32.26	\$32.29	\$32.57	\$32.81	\$33.22	\$33.55	\$32.48	
90mm	\$32.85	\$32.72	\$32.78	\$33.34	\$33.82	\$34.63	\$35.30	\$33.16	
100mm	\$33.38	\$33.18	\$33.28	\$34.11	\$34.83	\$36.05	\$37.05	\$33.84	
125mm	\$33.90	\$33.63	\$33.77	\$34.88	\$35.83	\$37.47	\$38.80	\$34.51	
150mm	\$34.43	\$34.09	\$34.26	\$35.65	\$36.84	\$38.88	\$40.55	\$35.19	
225mm	\$41.30	\$40.77	\$41.03	\$43.26	\$45.17	\$48.43	\$51.10	\$42.53	
300mm	\$47.65	\$46.98	\$47.32	\$50.10	\$52.48	\$56.57	\$59.90	\$49.18	



Fabricated Round Downpipe Spreader - using up to 2 metres of pipe

Diam		C/bond	Zinc	Gal	Ultra	Metallic	304 2b	316 2b	Matt
75mm		\$155.27	\$152.60	\$157.47	\$168.60	\$192.27	\$208.60	\$221.93	\$164.93
90mm		\$157.37	\$154.43	\$159.43	\$171.68	\$196.30	\$214.27	\$228.93	\$167.65
100mm		\$158.77	\$155.66	\$160.74	\$173.73	\$198.99	\$218.04	\$233.60	\$169.46
125mm		\$186.93	\$182.49	\$188.24	\$206.80	\$236.82	\$264.04	\$286.27	\$200.69
150mm		\$186.93	\$182.49	\$188.24	\$206.80	\$236.82	\$264.04	\$286.27	\$197.16
225mm		\$227.40	\$220.73	\$225.83	\$255.43	\$289.27	\$330.10	\$363.43	\$246.27
300mm		\$262.20	\$253.31	\$261.29	\$298.40	\$340.18	\$394.62	\$439.07	\$286.18

Rectangle / Square Downpipe

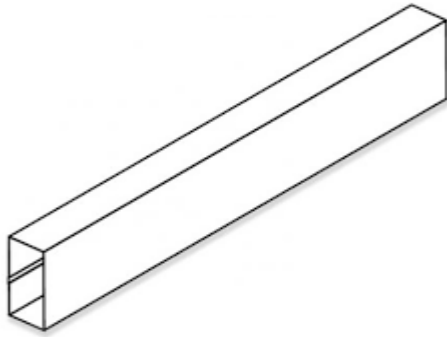

Up to 4 metre Lengths

Riveted Bends to make offset

Tapered downpipe

Clips

Downpipe is charged per metre with 1 metre minimum charge

Standard Pipe lead Time is 2 Working Days, offsets longer

.55mm Material - Price per lineal Metre

Size	C/bond	Zinc	Gal	Ultra	Metallic	304 2b	316 2b	Matt	
75mm x 75mm	\$30.10	\$28.63	\$32.02	\$38.14	\$43.38	\$52.37	\$59.70	\$36.12	
100mm x 75mm	\$30.10	\$28.63	\$32.02	\$38.14	\$43.38	\$52.37	\$59.70	\$36.12	
100mm x 50mm	\$30.10	\$28.63	\$32.02	\$38.14	\$43.38	\$52.37	\$59.70	\$36.12	
100mm x 100mm	\$39.58	\$37.36	\$41.12	\$50.40	\$58.34	\$71.96	\$83.07	\$47.34	
100mm x 150mm	\$39.58	\$37.36	\$41.12	\$50.40	\$58.34	\$71.96	\$83.07	\$47.34	
150mm x 150mm	\$48.33	\$45.00	\$49.32	\$63.23	\$75.15	\$95.57	\$112.23	\$58.65	
200mm x 200mm	\$56.24	\$52.35	\$56.95	\$73.18	\$87.09	\$110.91	\$130.35	\$67.84	
250mm x 250mm	\$64.15	\$59.71	\$64.58	\$83.13	\$99.02	\$126.24	\$148.47	\$77.02	

Adjustable Offset - .55mm Material - Price per unit

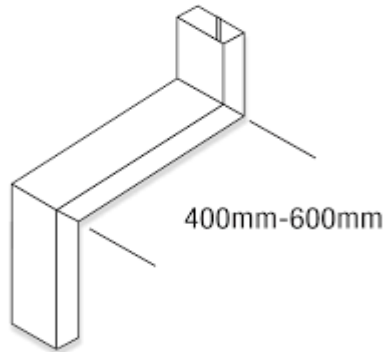

Size	C/bond	Zinc	Gal	Ultra	Metallic	304 2b	316 2b	Matt	
75mm x 75mm	\$166.20	\$163.27	\$170.03	\$182.28	\$192.77	\$224.87	\$239.53	\$178.25	
100mm x 75mm	\$166.20	\$163.27	\$170.03	\$182.28	\$192.77	\$224.87	\$239.53	\$178.25	
100mm x 50mm	\$166.20	\$163.27	\$170.03	\$182.28	\$192.77	\$224.87	\$239.53	\$178.25	
100mm x 100mm	\$185.17	\$180.72	\$188.24	\$206.80	\$222.69	\$264.04	\$286.27	\$200.69	
100mm x 150mm	\$199.30	\$194.86	\$202.38	\$220.93	\$236.82	\$278.18	\$300.40	\$214.82	
150mm x 150mm	\$216.80	\$210.13	\$218.77	\$246.60	\$270.43	\$325.40	\$358.73	\$237.43	
200mm x 200mm	\$246.75	\$238.97	\$248.16	\$280.63	\$308.44	\$366.08	\$404.97	\$269.94	
250mm x 250mm	\$274.57	\$265.68	\$275.42	\$312.53	\$344.31	\$408.76	\$453.20	\$300.31	

Rectangle / Square Downpipe

Offset - Fabricated to Size



Pricing Notes

* Allow for the amount of pipe required at per metre rates from previous page

* Add Price for 2 x Riveted Bends as per below (or as many bends as required)

.55mm Material - Price Per Each Riveted Bend - Labour Only

Pipe Size

	75 x 75	100 x 75	100 x 50	100 x 100	100 x 150	150 x 150	200 x 200	250 x 250
CB ZA GAL	\$53.00	\$53.00	\$53.00	\$53.00	\$60.07	\$60.07	\$67.13	\$73.13
SS	\$60.07	\$60.07	\$60.07	\$60.07	\$67.13	\$67.13	\$72.13	\$78.13

Riveted Elbow - 300mm x 300mm



Size	C/bond	Zinc	Gal	Ultra	Metallic	304 2b	316 2b	Matt
75mm x 75mm	\$83.10	\$81.63	\$85.02	\$91.14	\$96.38	\$112.43	\$119.77	\$89.12
100mm x 75mm	\$83.10	\$81.63	\$85.02	\$91.14	\$96.38	\$112.43	\$119.77	\$89.12
100mm x 50mm	\$83.10	\$81.63	\$85.02	\$91.14	\$96.38	\$112.43	\$119.77	\$89.12
100mm x 100mm	\$92.58	\$90.36	\$94.12	\$103.40	\$111.34	\$132.02	\$143.13	\$100.34
100mm x 150mm	\$99.65	\$97.43	\$101.19	\$110.47	\$118.41	\$139.09	\$150.20	\$107.41
150mm x 150mm	\$108.40	\$105.07	\$109.38	\$123.30	\$135.22	\$162.70	\$179.37	\$118.72
200mm x 200mm	\$123.38	\$119.49	\$124.08	\$140.32	\$154.22	\$183.04	\$202.48	\$134.97
250mm x 250mm	\$137.28	\$132.84	\$137.71	\$156.27	\$172.16	\$204.38	\$226.60	\$150.16

Rectangle / Square Downpipe Accessories



Clip Only Price - .55mm Material

Size	C/bond	Zinc	Gal	Ultra	Metallic	304 2b	316 2b	Matt	
75mm x 75mm	\$10.19	\$10.13	\$10.16	\$10.41	\$10.63	\$11.00	\$11.30	\$10.33	
100mm x 75mm	\$10.63	\$10.57	\$10.60	\$10.85	\$11.07	\$11.44	\$11.74	\$10.77	
100mm x 50mm	\$11.07	\$11.01	\$11.04	\$11.30	\$11.51	\$11.88	\$12.18	\$11.21	
100mm x 100mm	\$12.14	\$12.06	\$12.10	\$12.45	\$12.74	\$13.25	\$13.67	\$12.33	
100mm x 150mm	\$13.02	\$12.94	\$12.98	\$13.33	\$13.63	\$14.14	\$14.55	\$13.21	
150mm x 150mm	\$15.96	\$15.84	\$15.90	\$16.41	\$16.84	\$17.57	\$18.18	\$16.24	
200mm x 200mm	\$18.91	\$18.75	\$18.83	\$19.48	\$20.05	\$21.01	\$21.80	\$19.27	
250mm x 250mm	\$21.74	\$21.56	\$21.65	\$22.41	\$23.05	\$24.16	\$25.07	\$22.16	



Stock Zincalume Drop to Suit 100mm x 75mm Downpipe

\$9.60	EACH
--------	------



Fabricated Drop - up to 100mm long

Size	C/bond	Zinc	Gal	Ultra	Metallic	304 2b	316 2b	Matt	
75mm x 75mm	\$21.55	\$21.51	\$21.53	\$21.71	\$21.87	\$22.14	\$22.37	\$21.65	
100mm x 75mm	\$21.90	\$21.81	\$21.86	\$22.23	\$22.54	\$23.09	\$23.53	\$22.10	
100mm x 50mm	\$22.25	\$22.12	\$22.18	\$22.74	\$23.22	\$24.03	\$24.70	\$22.56	
100mm x 100mm	\$22.60	\$22.42	\$22.51	\$23.25	\$23.89	\$24.98	\$25.87	\$23.01	
100mm x 150mm	\$22.95	\$22.73	\$22.84	\$23.77	\$24.56	\$25.92	\$27.03	\$23.46	
150mm x 150mm	\$27.53	\$27.18	\$27.36	\$28.84	\$30.11	\$32.29	\$34.07	\$28.35	
200mm x 200mm	\$31.77	\$31.32	\$31.54	\$33.40	\$34.99	\$37.71	\$39.93	\$32.79	
250mm x 250mm	\$35.77	\$35.32	\$35.54	\$37.40	\$38.99	\$41.71	\$43.93	\$36.79	

Spiral Lockseam Downpipe



Up to 8 metre Lengths

90mm diam to 229mm diam

Riveted Bends to make offset

T brackets & Clips Available

Set up Charge applies if under 12 metres in order

Standard Pipe lead Time is 10 Working Days, offsets longer

.6mm Downpipe - Price per lineal Metre

Diam	Galvabond	T Bracket (40 x .55mm) & Clip (40 x .55)
90mm	\$33.53	\$22.09
102mm	\$35.53	\$24.20
152mm	\$43.53	\$25.96
203mm	\$63.53	\$31.81
229mm	\$75.53	\$37.66

.8mm Downpipe - Price per lineal Metre

Diam	Zincalume	Galvabond	T Bracket (40 x 3mm) & Clip (40 x .55)
90mm	\$35.53	\$41.53	\$30.48
102mm	\$41.53	\$43.53	\$35.02
152mm	\$53.53	\$57.53	\$35.02
203mm	\$77.53	\$79.53	\$39.76
229mm	\$89.53	\$93.53	\$44.51

1mm Downpipe - Price per lineal Metre

Diam	Zincalume	Galvabond
90mm	\$43.53	\$47.53
102mm	\$47.53	\$49.53
152mm	\$63.53	\$67.53
203mm	\$89.53	\$89.53
229mm	\$103.53	\$107.53

Riveted Bend - labour rate

Diam	.6mm	.8mm	1mm
90mm	\$53.00	\$63.60	\$84.80
102mm	\$60.07	\$74.20	\$95.40
152mm	\$67.13	\$84.80	\$109.53
203mm	\$81.27	\$95.40	\$123.67
229mm	\$88.33	\$106.00	\$134.27

Heavy Duty Spiral Lockseam Downpipe

Up to 8 metre Lengths

102mm diam to 229mm diam

Welded Bends to make offset

T brackets & Clips Available

Set up Charge applies if under 12 metres in order

Standard Pipe lead Time is 10 Working Days, offsets longer

1.2mm Downpipe - Price per lineal Metre

Diam	Zincalume	Galvabond	T Bracket (40 x 3mm) & Clip (40 x .55)
102mm	\$63.53	\$57.53	\$35.02
152mm	\$95.53	\$79.53	\$35.02
203mm	\$123.53	\$105.53	\$39.76
229mm	\$143.53	\$123.53	\$44.51

1.6mm Downpipe - Price per lineal Metre

Diam	Galvabond	T Bracket (3mm) & Welded Lug (3mm)
102mm	\$71.53	\$56.18
152mm	\$95.53	\$64.01
203mm	\$123.53	\$78.90
229mm	\$147.53	\$89.35

Welded Bend - labour rate

Diam	1.2mm	1.6mm
102mm	\$116.60	\$127.20
152mm	\$127.20	\$134.27
203mm	\$141.33	\$148.40
229mm	\$151.93	\$159.00

Stainless Steel Spiral Lockseam Downpipe

Up to 8 metre Lengths

90mm diam to 229mm diam

Riveted Bends to make offset

T brackets & Clips Available

Machine Marks / Scuffing will be visible from the Manufacturing Process

Set up Charge applies if under 12 metres in order

Standard Pipe lead Time is 10 Working Days, offsets longer

.6mm Downpipe - Price per lineal Metre

Diam		304 2b finish	316 2b finish	.55mm T & Clip
90mm		\$63.53	\$75.53	\$24.36
102mm		\$75.53	\$93.53	\$27.34
152mm		\$107.53	\$127.53	\$29.11
203mm		\$143.53	\$167.53	\$36.35
229mm		\$163.53	\$203.53	\$43.60

.9mm Downpipe - Price per lineal Metre

Diam		304 2b finish	316 2b finish	3mm T & .55mm Clip
90mm		\$103.53	\$127.53	\$37.02
102mm		\$123.53	\$147.53	\$44.56
152mm		\$167.53	\$203.53	\$44.56
203mm		\$213.53	\$253.53	\$52.83
229mm		\$253.53	\$313.53	\$61.11

Riveted Bend - labour rate

Diam		.6mm	.9mm	
90mm		\$63.60	\$84.80	
102mm		\$70.67	\$95.40	
152mm		\$84.80	\$109.53	
203mm		\$98.93	\$123.67	
229mm		\$106.00	\$134.27	

Hot Dip Galvanised Spiral Welded Downpipe

Up to 8 metre Lengths

90mm diam to 229mm diam

Welded Bends to make offset

T brackets & Clips Available

Set up Charge applies if under 12 metres in order

Standard Pipe lead Time is 20 Working Days, offsets longer

1.6mm Downpipe - Price per lineal Metre

Mild Steel + Hot Dip Galvanised				
Diam	Pipe	Welded Bend	T Bracket (5mm) & Welded Lug (5mm)	
90mm	\$75.87	\$106.00	\$52.78	
102mm	\$79.87	\$116.60	\$59.31	
152mm	\$110.27	\$127.20	\$72.90	
203mm	\$148.67	\$141.33	\$81.55	
229mm	\$175.87	\$151.93	\$81.55	

2mm Downpipe - Price per lineal Metre

Mild Steel + Hot Dip Galvanised				
Diam	Pipe	Welded Bend	T Bracket (5mm) & Welded Lug (5mm)	
90mm	\$91.07	\$116.60	\$52.78	
102mm	\$95.07	\$127.20	\$59.31	
152mm	\$136.67	\$134.27	\$72.90	
203mm	\$183.07	\$148.40	\$81.55	
229mm	\$219.87	\$159.00	\$81.55	

3mm Downpipe - Price per lineal Metre

Mild Steel + Hot Dip Galvanised				
Diam	Pipe	Welded Bend	T Bracket (5mm) & Welded Lug (5mm)	
90mm	\$127.47	\$123.67	\$52.78	
102mm	\$139.07	\$134.27	\$59.31	
152mm	\$193.87	\$141.33	\$72.90	
203mm	\$263.07	\$151.93	\$81.55	
229mm	\$293.47	\$162.53	\$81.55	

Stainless Steel Spiral Welded Downpipe

Up to 8 metre Lengths

90mm diam to 229mm diam

Welded Bends to make offset

T brackets & Clips Available

Machine Marks / Scuffing will be visible from the Manufacturing Process

Set up Charge applies if under 12 metres in order

Standard Pipe lead Time is 10 Working Days, offsets longer

1.2mm Downpipe - Price per lineal Metre

Diam	304 2b finish	316 2b finish	Welded Bend	T bkt & Clip
90mm	\$87.07	\$97.07	\$88.33	\$56.18
102mm	\$87.07	\$97.07	\$88.33	\$64.01
152mm	\$127.07	\$147.07	\$123.67	\$78.90
203mm	\$161.07	\$187.07	\$141.33	\$89.35
229mm	\$197.07	\$257.07	\$141.33	\$89.35

1.6mm Downpipe - Price per lineal Metre

Diam	304 2b finish	316 2b finish	Welded Bend	T bkt & Clip
90mm	\$117.07	\$167.07	\$88.33	56.18
102mm	\$117.07	\$167.07	\$88.33	64.01
152mm	\$177.07	\$227.07	\$123.67	78.90
203mm	\$227.07	\$307.07	\$141.33	89.35
229mm	\$267.07	\$357.07	\$141.33	89.35

2mm Downpipe - Price per lineal Metre

Diam	304 2b finish	316 2b finish	Welded Bend	T bkt & Clip
90mm	\$141.07	\$187.07	\$88.33	67.58
102mm	\$141.07	\$187.07	\$88.33	80.12
152mm	\$207.07	\$267.07	\$123.67	104.28
203mm	\$267.07	\$357.07	\$141.33	115.68
229mm	\$317.07	\$407.07	\$141.33	115.68

Ridge Vent System



Open Top



Closed Top

Open Top from 300mm Throat to 1200mm Throat

Closed Top from 300mm Throat to 600mm Throat

Supplied in Kit Form

Standard Lead Time is 10 Working Days

Engineered Data available - Open Top Version Only

.55mm Material - Price Per Lineal Metre

Small Quantity - Less Than 10 Metres

Throat	Open Top		Closed Top	
	c/bond	zinc	c/bond	zinc
300mm	\$428.02	\$413.65	\$304.59	\$290.52
450mm	\$588.96	\$552.44	\$461.13	\$439.32
600mm	\$788.67	\$744.57	\$586.42	\$560.29
750mm	\$980.54	\$946.01		
900mm	\$1,275.73	\$1,236.48		
1200mm	\$1,755.82	\$1,707.47		

Quantity - Greater Than 10 Metres

Throat	Open Top		Closed Top	
	c/bond	zinc	c/bond	zinc
300mm	\$406.62	\$392.97	\$289.36	\$275.99
450mm	\$559.51	\$524.82	\$438.08	\$417.35
600mm	\$749.24	\$707.35	\$557.10	\$532.27
750mm	\$931.51	\$898.71		
900mm	\$1,211.94	\$1,174.66		
1200mm	\$1,668.03	\$1,622.10		

Quantity Greater than 50 Metres - Ask for Pricing

Fixed Metal Louvres - Side Profiles

2 Stage Louvre

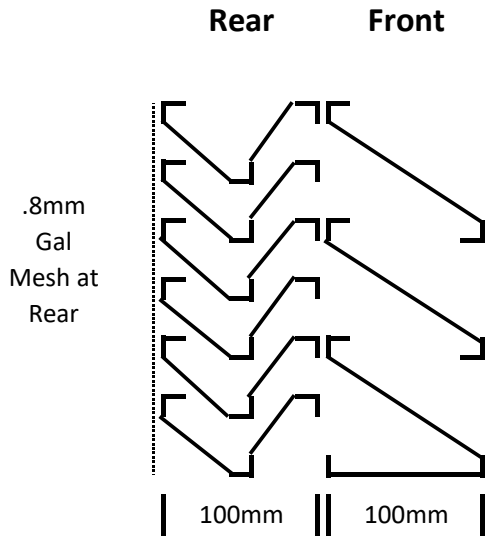

Basic 2 Stage Louvre

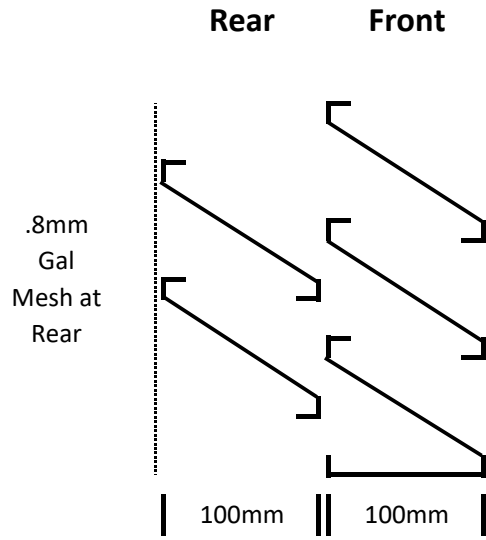

Standard Single Stage Louvre

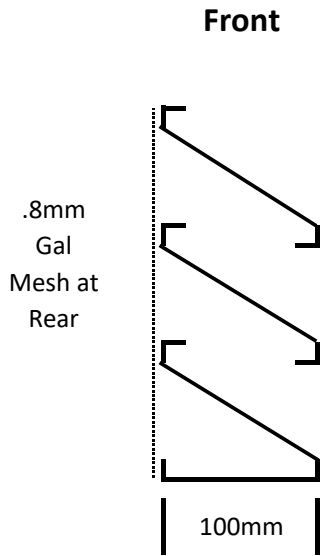

Stepped Single Stage Louvre

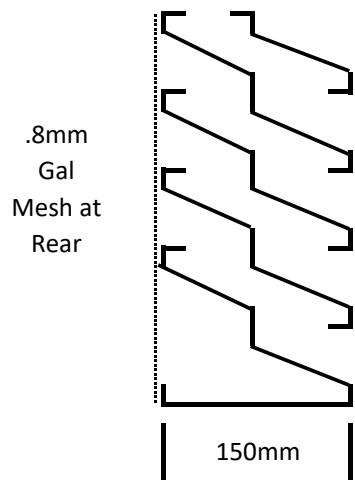

Louvres are charged per square metre - 1 metre minimum charge per Louvre

Fixed Louvres



- # 100mm wide Bank
- # .8mm Gal mesh at Back
- # .55mm Blades and Channel
- # Can add Perimeter Flashing
- # **Standard Lead Time 5 Working days**
- # **Minimum Charge 1m²**

Price Per Square Metre - .55mm Material

Version	C/bond	Zinc	Gal	Ultra	Metallic	Matt	
Standard Single Stage	\$362.60	\$347.44	\$372.46	\$440.65	\$499.04	\$418.19	
Stepped Single Stage	\$543.91	\$521.16	\$558.69	\$660.98	\$748.56	\$627.29	
Basic 2 Stage	\$815.86	\$781.73	\$838.03	\$991.46	\$1,122.84	\$940.93	
True 2 stage	\$1,269.11	\$1,216.03	\$1,303.60	\$1,542.28	\$1,746.65	\$1,463.67	

Extra Per Square Metre - Add Angle Flashing to Perimeter

C/bond	Zinc	Gal	Ultra	Metallic	Matt	
\$119.90	\$116.79	\$121.88	\$134.87	\$145.99	\$130.59	

OTHER UPGRADES

Change to Stainless Steel Mesh at Back - Extra per square metre

\$159.53

Curved Flashings

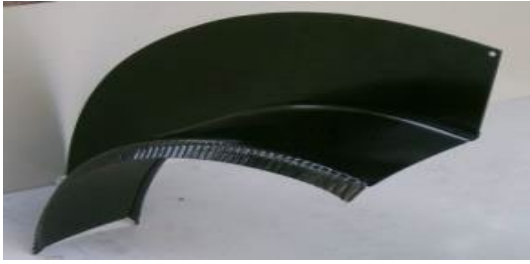

Single Curves - Aprons and Barge - Per Lineal Metre

Zincalume	\$107.33
Colorbond	\$112.67
Matt / Ultra / Metallic	\$132.27



Double Curves - Parapets - Per Lineal Metre

Zincalume	\$169.50
Colorbond	\$176.17
Matt / Ultra / Metallic	\$200.67

Additional Curve - Over and Above the Double - Per Lineal Metre

Zincalume	\$103.61
Colorbond	\$105.83
Matt / Ultra / Metallic	\$121.94

Safe Trays

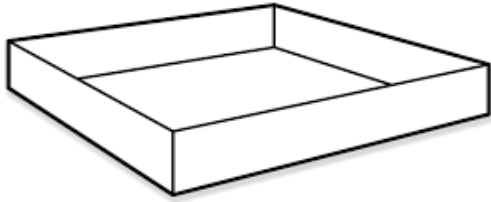

Safe Trays

.55mm Material - Price Per Each - 50mm sides

Square	C/bond	Zinc	Gal	Ultra	Metallic	304 2b	316 2b	Matt	
400mm	\$63.50	\$62.17	\$62.83	\$68.40	\$73.17	\$81.33	\$88.00	\$66.57	
450mm	\$63.50	\$62.17	\$62.83	\$68.40	\$73.17	\$81.33	\$88.00	\$66.57	
500mm	\$67.00	\$65.22	\$66.11	\$73.53	\$79.89	\$90.78	\$99.67	\$71.09	
550mm	\$67.00	\$65.22	\$66.11	\$73.53	\$79.89	\$90.78	\$99.67	\$71.09	
600mm	\$70.50	\$68.28	\$69.39	\$78.67	\$86.61	\$100.22	\$111.33	\$75.61	
700mm	\$81.07	\$78.40	\$79.73	\$90.87	\$100.40	\$116.73	\$130.07	\$87.20	
800mm	\$96.92	\$92.06	\$93.61	\$106.60	\$117.72	\$136.78	\$152.33	\$102.32	
900mm	\$112.73	\$108.29	\$110.51	\$129.07	\$144.96	\$172.18	\$194.40	\$122.96	
1000mm	\$130.33	\$125.00	\$127.67	\$149.93	\$169.00	\$201.67	\$228.33	\$142.60	
1090mm*	\$151.43	\$144.77	\$148.10	\$175.93	\$199.77	\$240.60	\$273.93	\$166.77	

Pricing Notes

* If 100mm sides, go up to next size for pricing

* If unequal sides - use the biggest side for pricing

* If larger than 1090mm square with 50mm side - will require lockseam join - Price on Request



Copper Safe Trays

.55mm Material - Price Per Each - 50mm sides

Square	Each	Square	Each
400mm	\$201.33	700mm	\$314.33
450mm	\$217.22	800mm	\$346.11
500mm	\$233.11	900mm	\$459.11
550mm	\$249.00	1000mm	\$540.33
600mm	\$264.89	1090mm*	\$688.67

Pricing Notes

* As per safe trays top of page

Other Items

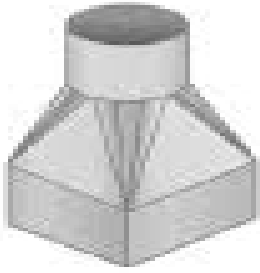

Transitions / Reducers

Square to Round

Rectangle to Round

Up to 300mm long overall

.55mm Material - Price Per Each

Pipe Sizes	C/bond	Zinc	Gal	Ultra	Metallic	304 2b	316 2b	Matt	
Up to 150mm	\$126.83	\$121.94	\$124.39	\$144.80	\$162.28	\$192.22	\$216.67	\$138.08	
151 to 300mm	\$162.00	\$154.89	\$158.44	\$188.13	\$213.56	\$257.11	\$292.67	\$178.36	

Lockseam Trays

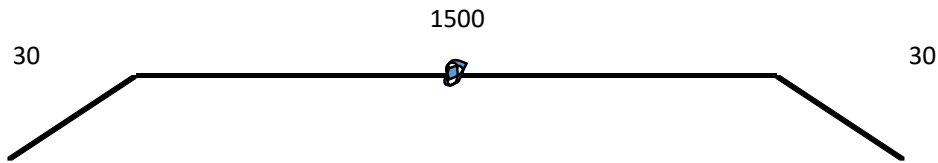

For anything over 1200mm girth and 1200mm long a Lockseam joint would be required.

For example to price above: total girth is 1575mm (1560mm + 15mm for joint)

charged as	1200mm girth x 2 bends		
plus	400mm flat		
plus	Lockseam Joint	\$12.37	per metre

Uprand Trays / Corner Notching

Price per corner to Notch prior to Folding	\$8.83	per corner
--	---------------	-------------------

MESH PRODUCTS 12mm X 12mm SQUARE

SUMP GUARDS				
	.8mm GAL	1.3mm GAL	1.3mm 304 SS	1.3mm 316 SS
300mm x 300mm x 150mm	59.00	77.87	100.07	105.47
400mm x 400mm x 150mm	61.40	80.75	111.83	119.39
500mm x 500mm x 150mm	81.67	101.53	142.23	152.13
600mm x 600mm x 150mm	84.27	104.65	154.97	167.21
700mm x 700mm x 150mm	87.67	108.73	171.63	186.93
800mm x 800mm x 150mm	108.33	130.00	204.00	222.00
900mm x 900mm x 150mm	108.33	130.00	204.00	222.00
DROP GUARDS				
	.8mm GAL	1.3mm GAL	1.3mm 304 SS	1.3mm 316 SS
100mm diam	36.53	36.77	41.21	42.29
150mm diam	44.40	44.80	52.20	54.00
225mm diam	56.00	56.60	67.70	70.40
FLASHINGS				
	.8mm GAL	1.3mm GAL	1.3mm 304 SS	1.3mm 316 SS
0 - 200mm Girth				
Flat	9.30	11.87	26.67	30.27
1 bend	11.07	13.63	28.43	32.03
2 bend	14.60	15.40	30.20	33.80
3 bend	16.37	17.17	31.97	35.57
4 bend	18.13	18.93	33.73	37.33
201mm to 400mm Girth				
Flat	11.90	14.99	39.41	45.35
1 bend	13.67	16.75	41.17	47.11
2 bend	17.20	18.52	42.94	48.88
3 bend	18.97	20.29	44.71	50.65
4 bend	20.73	22.05	46.47	52.41
401mm to 600mm Girth				
Flat	15.30	19.07	56.07	65.07
1 bend	17.07	20.83	57.83	66.83
2 bend	20.60	22.60	59.60	68.60
3 bend	22.37	24.37	61.37	70.37
4 bend	24.13	26.13	63.13	72.13
601mm to 900mm Girth				
Flat	21.80	26.87	87.92	102.77
1 bend	23.57	28.63	89.68	104.53
2 bend	27.10	30.40	91.45	106.30
3 bend	28.87	32.17	93.22	108.07
4 bend	30.63	33.93	94.98	109.83
901mm to 1200mm Girth				
Flat	25.30	31.07	105.07	123.07
1 bend	27.07	32.83	106.83	124.83
2 bend	30.60	34.60	108.60	126.60
3 bend	32.37	36.37	110.37	128.37
4 bend	34.13	38.13	112.13	130.13

BOLLARDS - CHS DOWNPIPE PROTECTOR

	Pre Galvanised Pipe		Hot Dip Galvanised Pipe	
Per Set	114.3mm OD x 3.6mm Wall	165.1mm OD x 3.5mm Wall	114.3mm OD x 3.6mm Wall	165.1mm OD x 3.5mm Wall
Up to 1625mm long	281.50	374.17	368.60	498.37
1626 to 2170mm long	334.00	451.67	450.93	615.53
2171 to 3250mm long	439.00	606.67	623.40	861.47
3251 to 6500mm long	754.00	1071.67	1133.00	1587.67
Extras - Factory Welded				
Welded Bend	123.67	176.67	123.67	176.67
Welded Sleeve	106.00	113.07	106.00	113.07

Per set includes:

2 x Welded Lugs to pipe (50mm x 5mm)

2 x Loose T Brackets (50mm x 5mm)

Standard Lead Times

Pre Galvanised 3 - 5 Days

Hot Dip Galvanised 2 - 3 weeks



Pre Galvanised Can often come out rough and dirty



Hot Dip Galvanised is a much cleaner finish



Stainless Steel Welded Products



Stainless Steel Products

PREVENTION OF TEA STAINING

This document is to become a standard attachment to all stainless steel quotes and accompanies an *ASSDA Technical Bulletin - Preventing Coastal Corrosion (Tea Staining) February 2010*.

It may be in your best interest to add this document or similar to your maintenance manuals to pass onto builders.

Tea Staining can only be prevented via regular maintenance - the duration required is dependant on many factors including: location to marine, atmospheric conditions and the finish of materials chosen.

The smoother the finish of material the more resistant it is to tea staining.

List of finishes from most resistant to least resistant

Electropolished

No 8 Finish - Mirror (1000 grit)

2B Finish

Bright Annealed Finish

No 4 Finish 320 - 400 grit

Gnerally what we stock and supply

Gutters & Flashings	2B and No 4 Finish
.55mm Downpipe	2B and No 4 Finish
1.6mm Tube	No 4 Finish
Flat bar brackets	No 4 Finish
Laser cut brackets	2B and No 4 Finish

If products are specified outside of our regular finishes above - longer lead times may apply

It is very important that we stress the most critical preventative tool to avoiding tea staining is regular cleaning of the products once installed

Futher information is available at www.assda.asn.au

Factory Welded Sumps



Welded Sump into Gutter - Price per each

Size	1.2mm 304	1.2mm 316	1.6mm 304	1.6mm 316
300mm Square	\$297.00	\$317.00	\$316.62	\$341.23
400mm Square	\$318.25	\$343.25	\$342.77	\$373.54
500mm Square	\$339.50	\$369.50	\$368.92	\$405.85
600mm Square	\$389.04	\$426.54	\$425.82	\$471.97
700mm Square	\$431.54	\$479.04	\$478.13	\$536.59
800mm Square	\$481.08	\$536.08	\$535.03	\$602.72
900mm Square	\$541.25	\$606.25	\$605.00	\$685.00
1000mm Square	\$605.00	\$685.00	\$683.46	\$781.92

Price Notes

- # When unequal sides - use the biggest side
- # Prices above cover up to 150mm Deep Sumps
- # If 151mm to 250mm Deep - go to next size up
- # If 251mm to 350mm Deep - go 2 sizes up

Option for Welded Drop into Any Sump as Extra

	1.2mm 304	1.2mm 316	1.6mm 304	1.6mm 316
100 or 150mm	\$74.25	\$79.25	\$79.15	\$85.31
225mm	\$84.25	\$89.25	\$89.15	\$95.31

Factory Welded Accessories

Welded Stop End - Price per each

Gutter Girth	1.2mm 304	1.2mm 316	1.6mm 304	1.6mm 316
Up to 600mm	\$84.85	\$89.85	\$89.75	\$95.91
601 to 900mm	\$109.61	\$117.11	\$116.96	\$126.19
901 to 1200mm	\$130.86	\$143.36	\$143.12	\$158.50
1201 to 1500mm	\$157.03	\$172.03	\$171.74	\$190.20

Welded Round Overflow - Price per each

Size	1.2mm 304	1.2mm 316	1.6mm 304	1.6mm 316
Up to 100mm diam	\$113.17	\$123.17	\$122.97	\$135.28
150mm diam	\$130.86	\$143.36	\$143.12	\$158.50
225mm diam	\$201.63	\$224.13	\$223.69	\$251.38
300mm diam	\$272.42	\$307.42	\$306.74	\$349.82

Welded Square / Rectangle Spitters - Price per each

Size	1.2mm 304	1.2mm 316	1.6mm 304	1.6mm 316
100mm x 100mm	\$113.17	\$123.17	\$122.97	\$135.28
150mm x 150mm	\$123.79	\$136.29	\$136.05	\$151.44
200mm x 200mm	\$183.96	\$206.46	\$206.03	\$233.72
300mm x 300mm	\$254.75	\$289.75	\$289.08	\$332.15

Welded Round Drop - Price per each

Size	1.2mm 304	1.2mm 316	1.6mm 304	1.6mm 316
Up to 100mm diam	\$97.25	\$106.00	\$105.84	\$116.61
150mm diam	\$109.63	\$119.63	\$119.44	\$131.75
225mm diam	\$134.39	\$146.89	\$146.65	\$162.04
300mm diam	\$159.15	\$174.15	\$173.86	\$192.32

Welded Square / Rectangle Drop - Price per each

Size	1.2mm 304	1.2mm 316	1.6mm 304	1.6mm 316
100mm x 100mm	\$97.25	\$106.00	\$105.84	\$116.61
150mm x 150mm	\$109.63	\$119.63	\$119.44	\$131.75
200mm x 200mm	\$134.39	\$146.89	\$146.65	\$162.04
300mm x 300mm	\$159.15	\$174.15	\$173.86	\$192.32

Factory Welded Rainheads



Rectangular Style Rainheads

	Price per Each			
Width	1.2mm 304	1.2mm 316	1.6mm 304	1.6mm 316
300mm	\$537.42	\$572.42	\$607.08	\$650.15
400mm	\$597.58	\$642.58	\$677.05	\$732.44
500mm	\$679.00	\$739.00	\$773.18	\$847.03
600mm	\$739.17	\$809.17	\$843.15	\$929.31
750mm	\$820.58	\$905.58	\$939.28	\$1,043.90
900mm	\$919.67	\$1,019.67	\$1,053.08	\$1,176.15
1200mm	\$1,103.60	\$1,223.60	\$1,263.69	\$1,411.38

Price Notes

* Fitted Drop is included in Price

Conical Style Rainheads

	Price per Each			
Width	1.2mm 304	1.2mm 316	1.6mm 304	1.6mm 316
300mm	\$502.08	\$537.08	\$571.74	\$614.82
400mm	\$562.25	\$607.25	\$641.72	\$697.10
500mm	\$643.67	\$703.67	\$737.85	\$811.69
600mm	\$703.83	\$773.83	\$807.82	\$893.97
750mm	\$785.25	\$870.25	\$903.95	\$1,008.56
900mm	\$866.67	\$966.67	\$1,000.08	\$1,123.15
1200mm	\$1,040.00	\$1,160.00	\$1,200.09	\$1,347.78

Price Notes

* Fitted Drop is included in Price

Option for Overflow Hole or Fitted Overflow - Extra

	1.2mm 304	1.2mm 316	1.6mm 304	1.6mm 316
Hole Cut Only	\$53.00	\$53.00	\$53.00	\$53.00
Fitted Overflow	\$116.63	\$119.13	\$119.08	\$122.15

Welded Rainheads



Flat Bottom Style Rainheads

Width	Price per Each			
	1.2mm 304	1.2mm 316	1.6mm 304	1.6mm 316
300mm	\$502.08	\$537.08	\$571.74	\$614.82
400mm	\$562.25	\$607.25	\$641.72	\$697.10
500mm	\$643.67	\$703.67	\$737.85	\$811.69
600mm	\$703.83	\$773.83	\$807.82	\$893.97
750mm	\$785.25	\$870.25	\$903.95	\$1,008.56
900mm	\$866.67	\$966.67	\$1,000.08	\$1,123.15
1200mm	\$1,040.00	\$1,160.00	\$1,200.09	\$1,347.78

Price Notes

* Fitted Drop is included in Price

Option for Overflow Hole or Fitted Overflow - Extra

	1.2mm 304	1.2mm 316	1.6mm 304	1.6mm 316
Hole Cut Only	\$53.00	\$53.00	\$53.00	\$53.00
Fitted Overflow	\$116.63	\$119.13	\$119.08	\$122.15

Welded Stainless Half Round Gutters

Smooth Rolled Up to 2.4 metres length

Turn in at Front as Standard

Can Weld Lengths together to send out up to 7.2 metre length

Price per lineal Metre

Diam	1.2mm 304	1.2mm 316		
150mm	\$74.33	\$86.83		
175mm	\$84.23	\$98.23		
200mm	\$98.39	\$114.89		
225mm	\$110.43	\$128.93		
250mm	\$130.96	\$153.46		
300mm	\$148.65	\$173.65		
350mm	\$155.72	\$180.72		
400mm	\$198.91	\$232.41		
450mm	\$228.74	\$267.27		

Laser Cut A4 Style Brackets - 2b Stainless Steel

Diam		304	316	
150mm		\$38.36	\$45.56	
175mm		\$42.22	\$50.44	
200mm		\$47.12	\$56.76	
225mm		\$54.16	\$65.73	
250mm		\$60.06	\$73.23	
300mm		\$70.01	\$85.67	
350mm		\$84.96	\$104.50	
400mm		\$115.26	\$142.88	
450mm		\$144.94	\$179.99	

Welded Stop Ends

Diam	1.2mm 304	1.2mm 316		
150mm	\$81.29	\$83.79		
175mm	\$81.29	\$83.79		
200mm	\$81.29	\$83.79		
225mm	\$85.54	\$89.04		
250mm	\$105.33	\$109.33		
300mm	\$109.58	\$114.58		
350mm	\$137.88	\$145.38		
400mm	\$166.17	\$176.17		
450mm	\$191.09	\$202.59		

Welded Stainless Half Round Gutters

Smooth Rolled Up to 2.4 metres length

Turn in at Front as Standard

Can Weld Lengths together to send out up to 7.2 metre length

Welded Gutter Joint

Diam	1.2mm 304	1.2mm 316		
150mm	\$70.67	\$70.67		
175mm	\$70.67	\$70.67		
200mm	\$70.67	\$70.67		
225mm	\$70.67	\$70.67		
250mm	\$88.33	\$88.33		
300mm	\$88.33	\$88.33		
350mm	\$106.00	\$106.00		
400mm	\$123.67	\$123.67		
450mm	\$142.22	\$142.22		

Welded Drop into Gutter

Diam	1.2mm 304	1.2mm 316		
90mm	\$81.29	\$83.79		
100mm	\$81.29	\$83.79		
150mm	\$87.67	\$91.67		
225mm	\$109.58	\$114.58		
300mm	\$131.50	\$137.50		

Stainless Steel Tube / Downpipe

6 metre lengths as standard

Charged in 6 metre increments

320 grit polished finish as standard



Per Lineal Metre (6 metre charge)

Outside Diam	304 grade	316 grade
88.9mm x 1.6mm	\$134.13	\$154.13
101.6mm x 1.6mm	\$134.13	\$154.13
152.4mm x 1.6mm	\$164.13	\$224.13
203.2mm x 2.0mm	\$428.27	\$588.27

Factory Welded Bend

Outside Diam	304 grade	316 grade
88.9mm x 1.6mm	\$88.33	\$88.33
101.6mm x 1.6mm	\$88.33	\$88.33
152.4mm x 1.6mm	\$123.67	\$123.67
203.2mm x 2.0mm	\$141.33	\$141.33

Factory Welded Sleeve

Outside Diam	304 grade	316 grade
88.9mm x 1.6mm	\$88.33	\$88.33
101.6mm x 1.6mm	\$88.33	\$88.33
152.4mm x 1.6mm	\$123.67	\$123.67
203.2mm x 2.0mm	\$141.33	\$141.33

T Bracket (3mm) & Clip (1.2mm) To Suit per set

Outside Diam	304 grade	316 grade
88.9mm x 1.6mm	\$52.78	\$56.18
101.6mm x 1.6mm	\$59.31	\$64.01
152.4mm x 1.6mm	\$72.90	\$78.90
203.2mm x 2.0mm	\$81.55	\$89.35

T Bracket (5mm) & Clip (1.2mm) To Suit per set

Outside Diam	304 grade	316 grade
88.9mm x 1.6mm	\$62.38	\$67.58
101.6mm x 1.6mm	\$73.52	\$80.12
152.4mm x 1.6mm	\$86.78	\$104.28
203.2mm x 2.0mm	\$104.28	\$115.68

Powder Coating

We use the services of two Professional Powder Coaters

Material is pre treated prior to coating

Dulux or Interpon Range

Can offer Warranty on Aluminium or Steel Substrates

Colour selection catalogue available

Minimum charge starts at \$100

Rates start at \$45 per m² depending on level of finish required

Standard Lead time is 5 - 7 working days for coating process

We can colour match from scratch - lead times and minimum costs apply

Dulux Duralloy Standard Range - Match Colorbond

Cost below is additional to Flashing Rates

Girth	per metre
100mm	\$7.00
200mm	\$14.00
300mm	\$21.00
400mm	\$28.00
500mm	\$35.00

Girth	per metre
600mm	\$42.00
800mm	\$56.00
1000mm	\$70.00
1200mm	\$84.00
1500mm	\$105.00

Notes to Consider

* Position of hanging holes

* Length size to avoid warping, especially for narrow profiles

Laser Cutting

We use the services of Professional Laser Cutters as required

Up to 6 metre lengths

Any material can be cut

Minimum charge starts at \$150

Standard lead time is 5 - 7 working days for cutting process

Galvanising

We use the services of two Professional Hot Dip Galvanising Plants

Minimum charge starts at \$325

Standard Lead time is 10 - 15 working days

Per Kg rate starts at \$3.50



Technical Data

Data Sheets available on request for



Colorbond XRW

Colorbond Permagard

Colorbond Matt

Colorbond Ultra

Colorbond Metallic

Galvabond G2

Zincalume G300

Colorbond Coolmax



Duralloy

Duratech

Precious

Electro

Alphatec

Fluoraset