

---

# COMMERCIAL SHEET METAL

---



---

## PRODUCT GUIDE

---

15th February 2025

Supercedes August 2023

ORDER PROCESSING

Brad

DESPATCH

Glen

ORDERS

[orders@commercialsheetmetal.com.au](mailto:orders@commercialsheetmetal.com.au)

ESTIMATING

[quotes@commercialsheetmetal.com.au](mailto:quotes@commercialsheetmetal.com.au)

OFFICE

3803 3200

7am to 5pm

195 MAGNESIUM DRIVE

CRESTMead QLD 4132

---

# INDEX

---

	<b>Page</b>
Stock Materials	
Bluescope	3
Delivery and Packaging	4
<b>Flashings</b>	<b>6</b>
Colorbond Range	7
Zincalume	11
Galvabond	13
Stainless Steel	17
Aluminium	22
<b>Commercial Gutter Range</b>	<b>23</b>
Half Round Gutter	26
Commercial High Front Slotted Eaves Gutter	34
OG Style Gutters	40
Quad Gutter	42
<b>Light gauge Fabrication</b>	<b>43</b>
Box Gutter & Accessories	46
Sumps	48
Rainheads	50
Round Downpipe	52
Rectangle Downpipe	56
Spiral Downpipe Range	59
Ridge Vents	64
Fixed Metal Louvre Range	65
Curved Flashings	67
Safe Trays	68
Other Items	69
Mesh	71
Welded Fabrication	
Bollard - Downpipe Protectors	72
Stainless Steel Welded Products	74
Sumps	76
Rainheads	78
Half Round Gutter	80
Downpipe	82
External Services	83
Technical Information	85



**1200mm Wide Stock Coil - .55mm Standard Colorbond Range**

Surfmist®	Evening Haze®	Shale Grey™	Dune®	Dover White™
Windspray®	Gully™	Wallaby™	Jasper®	Basalt™
Manor Red®	Night Sky®	Deep Ocean®	Cottage Green®	Ironstone®
Monument®	Classic Cream™	Paperbark®	Pale Eucalypt®	Woodland Grey®
Southerly®	Bluegum®			

**1200mm Wide Stock Coil - .55mm Premium Colorbond Range\***

<b>Ultra</b>	<b>Metallic</b>	<b>Matt</b>	<b>Others</b>
Surfmist®	Aries®	Surfmist®	Cattai Green
Dune®	Astro®	Basalt™	Thredbo White
Windspray®	Celestian®	Bluegum®	
Monument®	Rhea®	Monument®	Coolmax Whitehaven
Woodland Grey®	Galactic®	Dune®	
Wallaby™	Cosmic®	Shale Grey™	
Deep Ocean®			
Shale Grey™			

\* Stock is limited for these ranges - Lead times are generally 3 - 5 weeks for extra supply

\* Advise Job needs and we will pre order and hold in stock

**1200mm Wide Stock Coil - 1mm and 1.2mm Colorbond Range**

Surfmist®

**1200mm Wide Stock Coil - Zinalume® and Galvabond®**

**Zinalume®**

**Galvabond®**

.55mm	.8mm
1mm	1.2mm

.55mm	.8mm	1mm
1.2mm	1.6mm	
2mm	3.6 metre sheets	
3mm	3.6 metre sheets	

# Deliveries

# We have 4 vehicles on the road each day

# We cover from The Tweed to Sunshine Coast and out to Ipswich Daily

# We can arrange delivery to regional areas on request

# Deliveries start from 5:30am and are complete most days by 1:30pm

## Your Delivery Rates

Location		Location	
Brisbane	\$60.00	Gold Coast	\$60.00
<b>North</b>		<b>South</b>	
Caboolture	\$60.00	Tweed Heads	\$90.00
Kilcoy	\$175.00	Murwillumbah	\$150.00
Kingaroy	\$350.00	Byron Bay	\$200.00
Maroochydore	\$100.00	Ballina	\$250.00
Noosa	\$150.00	Lismore	\$250.00
Gympie	\$250.00	Grafton	\$550.00
Maryborough	\$400.00		
Hervey Bay	\$500.00		
Bundaberg	\$600.00	<b>West</b>	
		Ipswich	\$60.00
<b>South West</b>		Gatton	\$90.00
Beaudesert	\$100.00	Toowoomba	\$125.00
Warwick	\$250.00	Oakey	\$200.00
Stanthorpe	\$350.00		

# Packaging Options

## PLASTIC WRAPPED

Plastic Wrapped with foam sections between flashings

\$9 per lineal metre of pack

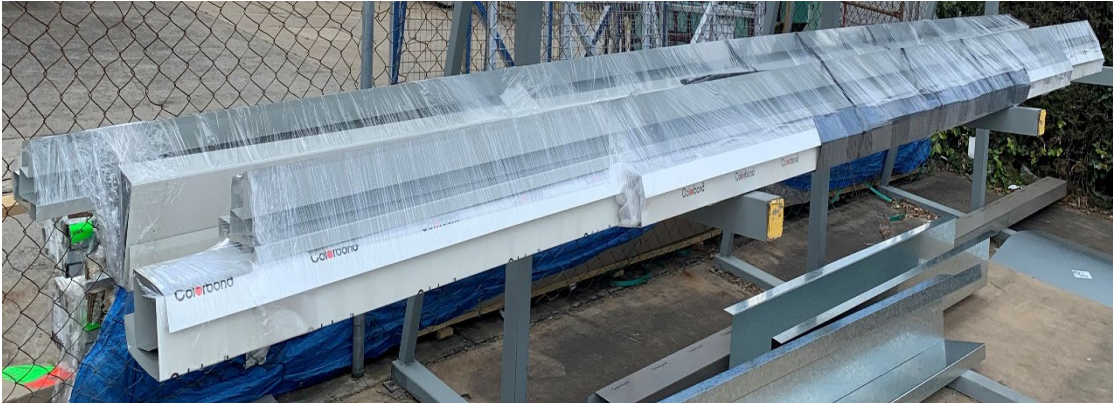

## STILLAGES

Packed into Stillages - usually for long distance travel

\$50 per lineal metre of stillage

Stillage packing involves

Plastic wrapped around stillage



Goods placed inside stillage with plastic corflute and tape for protection

.55mm Material folded into box gutter profile top and bottom



# Flashings

# Order by 4:00 pm for Next Day Availability (Mon to Thurs)

# Order by 2:00 pm for Next Day Availability (Friday)

# Up to 8 Metre Lengths

.55mm up to 1.6mm Thick

# Up to 3.6 Metre Lengths for Heavy Gauge Materials

2mm and Up

Heavy gauge not available for next day delivery

# Ability to fold any profile required on your Job

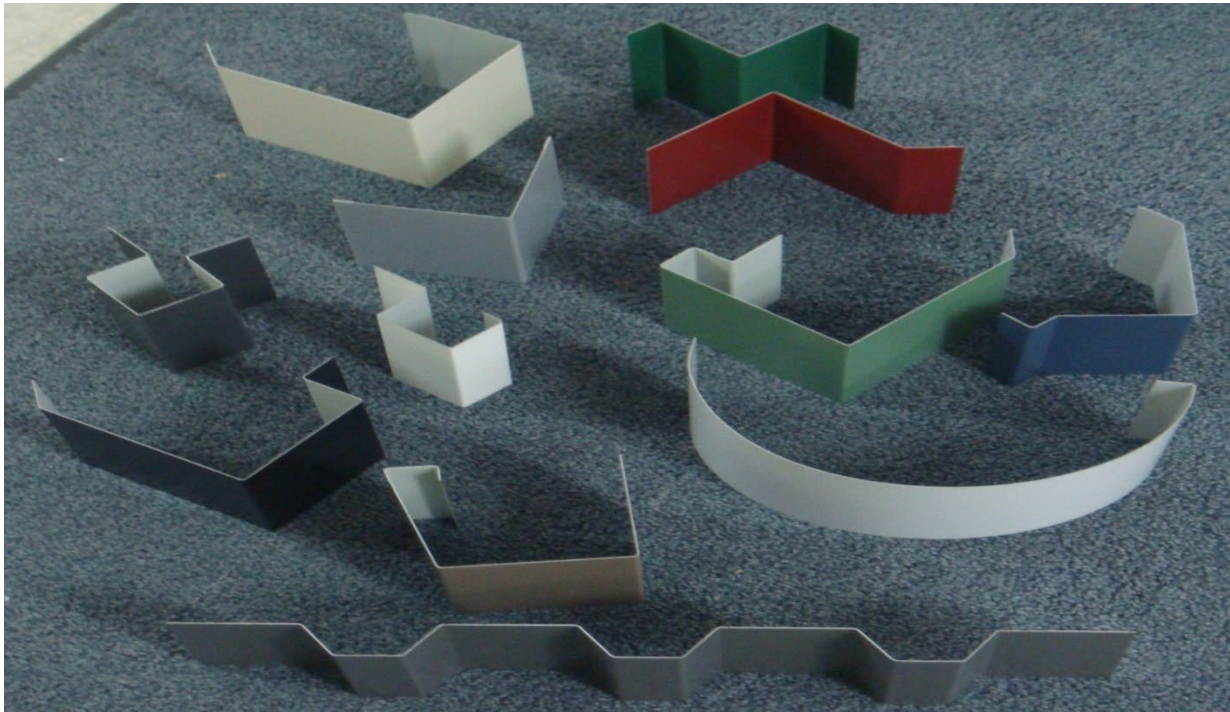

# Preferred ordering method is via email with PDF attachment:

[orders@commercialsheetmetal.com.au](mailto:orders@commercialsheetmetal.com.au)

1 Metre Minimum Charge for all Flashings

Squash Fold is charged as 2 folds

No Additional Charge for Taper Flashings





COLORBOND® XRW prepainted steel

AM100 G300S steel with Activate® technology

**.55mm COLORBOND STANDARD RANGE**

BENDS

GIRTH	FLAT	1	2	3	4	5	6	7	8
up to 100mm	5.56	6.46	7.35	8.25	9.14	10.04	10.94	11.83	12.73
101 to 150mm	7.15	8.05	8.95	9.84	10.74	11.63	12.53	13.43	14.32
151 to 200mm	8.75	9.64	10.54	11.44	12.33	13.23	14.12	15.02	15.92
201 to 240mm	10.02	10.92	11.82	12.71	13.61	14.50	15.40	16.30	17.19
241 to 300mm	11.94	12.83	13.73	14.63	15.52	16.42	17.31	18.21	19.11
301 to 400mm	15.13	16.02	16.92	17.81	18.71	19.61	20.50	21.40	22.29
401 to 500mm	19.59	20.49	21.38	22.28	23.17	24.07	24.97	25.86	26.76
501 to 600mm	20.59	21.49	22.38	23.28	24.18	25.07	25.97	26.86	27.76
601 to 800mm	29.16	30.05	30.95	31.85	32.74	33.64	34.53	35.43	36.33
801 to 1000mm	36.13	37.03	37.92	38.82	39.71	40.61	41.51	42.40	43.30
1001 to 1200mm	39.28	40.18	41.07	41.97	42.87	43.76	44.66	45.55	46.45

**COLOURS WE STOCK - BLUESCOPE STANDARD RANGE**

Basalt™	Dover White	Paperbark®
Classic Cream™	Ironstone®	Shale Grey™
Bluegum®	Jasper®	Surfmist®
Cottage Green®	Manor Red®	Wallaby™
Deep Ocean®	Monument®	Woodland Grey®
Dune®	Night Sky®	Windspray®
Evening Haze®	Pale Eucalypt®	Southerley
	Gully™	

**COLOURS WE NO LONGER STOCK - Available on Request**

**# These are subject to large Minimum Order Quantities and 8 week lead time**

Bushland®	Loft®	Terrain®
Cove™	Mangrove®	Wilderness®
Headland®	Sandbank®	

# GST Exclusive # 1 metre minimum charge per flashing # Squash Fold is 2 bends # Valid from February 2025



**COLORBOND®** prepainted Matt finish steel, specifically designed by BlueScope to provide a highly durable, wall cladding and roofing material with a soft and subtle look for general use.

AM100 G300S steel with Activate® technology

## COLORBOND® steel Matt

### BENDS

GIRTH	FLAT	1	2	3	4	5	6	7	8
up to 100mm	6.94	7.84	8.74	9.63	10.53	11.42	12.32	13.22	14.11
101 to 200mm	11.05	11.95	12.84	13.74	14.63	15.53	16.43	17.32	18.22
201 to 300mm	15.16	16.05	16.95	17.85	18.74	19.64	20.53	21.43	22.33
301 to 400mm	19.26	20.16	21.06	21.95	22.85	23.74	24.64	25.54	26.43
401 to 600mm	27.48	28.37	29.27	30.17	31.06	31.96	32.85	33.75	34.65
601 to 900mm	45.96	46.85	47.75	48.65	49.54	50.44	51.33	52.23	53.13
901 to 1200mm	52.12	53.01	53.91	54.81	55.70	56.60	57.49	58.39	59.29

### MATT RANGE - Refer to most recent Stock List for Availability

Surfmist®	Stocked	Dune®	Not Stocked
Monument®	Stocked	Shale Grey™	Not Stocked
Basalt™	Not Stocked	Bluegum®	Not Stocked



**COLORBOND®** Ultra prepainted steel, specifically designed by BlueScope combines long term durability and excellent corrosion resistance.

AM150 G300S steel with Activate® technology

## .55mm COLORBOND ULTRA

### BENDS

GIRTH	FLAT	1	2	3	4	5	6	7	8
up to 100mm	7.49	8.39	9.28	10.18	11.07	11.97	12.87	13.76	14.66
101 to 200mm	12.14	13.04	13.93	14.83	15.73	16.62	17.52	18.41	19.31
201 to 300mm	16.79	17.69	18.59	19.48	20.38	21.27	22.17	23.07	23.96
301 to 400mm	21.45	22.34	23.24	24.13	25.03	25.93	26.82	27.72	28.61
401 to 600mm	30.75	31.65	32.54	33.44	34.33	35.23	36.13	37.02	37.92
601 to 900mm	51.68	52.58	53.48	54.37	55.27	56.16	57.06	57.96	58.85
901 to 1200mm	58.66	59.56	60.45	61.35	62.25	63.14	64.04	64.93	65.83

### ULTRA RANGE - refer to most recent Stock List for Availability

Surfmist®	Stocked	<b>## Any Colour can be Made in Ultra - Minimum Order Quantities and approx 5 week lead times apply ##</b>	
Monument®	Stocked		
Woodland Grey®	Stocked		
Windspray®	Stocked		
Dune®	Stocked		
Shale Grey™	Not Stocked	Wallaby™	Not Stocked

# GST Exclusive # 1 metre minimum charge per flashing # Squash Fold is 2 bends # Valid from February 2025





COLORBOND® Metallic prepainted steel has been designed by BlueScope to provide an aesthetically distinctive "metallic" effect.

AM100 G300S steel with Activate® technology

**.55mm COLORBOND METALLIC**

**BENDS**

GIRTH	FLAT	1	2	3	4	5	6	7	8
up to 100mm	8.72	9.62	10.51	11.41	12.30	13.20	14.10	14.99	15.89
101 to 200mm	14.60	15.50	16.39	17.29	18.19	19.08	19.98	20.87	21.77
201 to 300mm	20.48	21.38	22.28	23.17	24.07	24.96	25.86	26.76	27.65
301 to 400mm	26.37	27.26	28.16	29.05	29.95	30.85	31.74	32.64	33.53
401 to 600mm	38.13	39.03	39.92	40.82	41.71	42.61	43.51	44.40	45.30
601 to 900mm	64.60	65.49	66.39	67.29	68.18	69.08	69.97	70.87	71.77
901 to 1200mm	73.42	74.32	75.21	76.11	77.00	77.90	78.80	79.69	80.59

**METALLIC RANGE - None held as stock - Only for Jobs**

Aries™	Astro™	Celestian™
Cosmic™	Galactic™	Rhea™

**# These are subject to Minimum Order Quantities and 6 week lead time**

# GST Exclusive # 1 metre mininum charge per flashing # Squash Fold is 2 bends # Valid from February 2025



**1mm COLORBOND SURFMIST**

BENDS									
GIRTH	FLAT	1	2	3	4	5	6	7	8
up to 100mm	10.70	12.19	13.68	15.18	16.67	18.16	19.66	21.15	22.64
101 to 200mm	16.66	18.16	19.65	21.14	22.64	24.13	25.62	27.12	28.61
201 to 300mm	22.63	24.12	25.62	27.11	28.60	30.10	31.59	33.08	34.58
301 to 400mm	28.60	30.09	31.59	33.08	34.57	36.07	37.56	39.05	40.55
401 to 600mm	40.53	42.03	43.52	45.01	46.51	48.00	49.49	50.99	52.48
601 to 900mm	67.39	68.88	70.37	71.87	73.36	74.85	76.35	77.84	79.33
901 to 1200mm	76.34	77.83	79.33	80.82	82.31	83.81	85.30	86.79	88.29

**# 15mm Required for squash fold on 1mm thick material**

**1.2mm COLORBOND SURFMIST**

BENDS									
GIRTH	FLAT	1	2	3	4	5	6	7	8
up to 100mm	12.70	14.49	16.28	18.07	19.86	21.66	23.45	25.24	27.03
101 to 200mm	19.72	21.51	23.30	25.09	26.88	28.68	30.47	32.26	34.05
201 to 300mm	26.74	28.53	30.32	32.11	33.90	35.70	37.49	39.28	41.07
301 to 400mm	33.76	35.55	37.34	39.13	40.93	42.72	44.51	46.30	48.09
401 to 600mm	47.80	49.59	51.38	53.17	54.97	56.76	58.55	60.34	62.13
601 to 900mm	79.39	81.18	82.97	84.77	86.56	88.35	90.14	91.93	93.73
901 to 1200mm	89.92	91.71	93.51	95.30	97.09	98.88	100.67	102.47	104.26

**# 20mm Required for squash fold on 1.2mm thick material**

# GST Exclusive # 1 metre minimum charge per flashing # Squash Fold is 2 bends # Valid from February 2025



ZINCALUME® G300 steel with Activate® technology is a hot- dipped aluminium / zinc / magnesium alloy coated structural steel with a regular spangle surface, a guaranteed minimum yield strength of 300MPa with good ductility.

### .55mm ZINCALUME G300 AM 125

#### BENDS

GIRTH	FLAT	1	2	3	4	5	6	7	8
up to 100mm	4.90	5.79	6.69	7.59	8.48	9.38	10.27	11.17	12.07
101 to 150mm	6.16	7.06	7.95	8.85	9.75	10.64	11.54	12.43	13.33
151 to 200mm	7.43	8.32	9.22	10.11	11.01	11.91	12.80	13.70	14.59
201 to 240mm	8.44	9.33	10.23	11.13	12.02	12.92	13.81	14.71	15.61
241 to 300mm	9.95	10.85	11.75	12.64	13.54	14.43	15.33	16.23	17.12
301 to 400mm	12.00	12.90	13.79	14.69	15.58	16.48	17.38	18.27	19.17
401 to 500mm	16.02	16.92	17.81	18.71	19.60	20.50	21.40	22.29	23.19
501 to 600mm	16.82	17.71	18.61	19.50	20.40	21.30	22.19	23.09	23.98
601 to 800mm	23.60	24.50	25.40	26.29	27.19	28.08	28.98	29.88	30.77
801 to 1000mm	28.62	29.52	30.41	31.31	32.20	33.10	34.00	34.89	35.79
1001 to 1200mm	31.73	32.62	33.52	34.41	35.31	36.21	37.10	38.00	38.89

### .8mm ZINCALUME G300 AM 125

#### BENDS

GIRTH	FLAT	1	2	3	4	5	6	7	8
up to 100mm	7.15	8.35	9.54	10.74	11.93	13.13	14.32	15.52	16.71
101 to 200mm	10.52	11.72	12.91	14.11	15.30	16.50	17.69	18.89	20.08
201 to 300mm	13.89	15.09	16.28	17.48	18.67	19.87	21.06	22.26	23.45
301 to 400mm	17.26	18.46	19.65	20.85	22.04	23.24	24.43	25.63	26.82
401 to 600mm	24.01	25.20	26.39	27.59	28.78	29.98	31.17	32.37	33.56
601 to 900mm	37.15	38.34	39.54	40.73	41.93	43.12	44.32	45.51	46.71
901 to 1200mm	44.23	45.42	46.62	47.81	49.01	50.20	51.40	52.59	53.78

# GST Exclusive # 1 metre minimum charge per flashing # Squash Fold is 2 bends # Valid from February 2025



ZINCALUME® G300 steel with Activate® technology is a hot-dipped aluminium / zinc / magnesium alloy coated structural steel with a regular spangle surface, a guaranteed minimum yield strength of 300MPa with good ductility.

### 1mm ZINCALUME G300 AM 125

#### BENDS

GIRTH	FLAT	1	2	3	4	5	6	7	8
up to 100mm	8.94	10.44	11.93	13.42	14.92	16.41	17.90	19.40	20.89
101 to 200mm	13.15	14.65	16.14	17.63	19.13	20.62	22.11	23.61	25.10
201 to 300mm	17.37	18.86	20.35	21.85	23.34	24.83	26.33	27.82	29.31
301 to 400mm	21.58	23.07	24.57	26.06	27.55	29.05	30.54	32.03	33.53
401 to 600mm	30.01	31.50	32.99	34.49	35.98	37.47	38.97	40.46	41.95
601 to 900mm	48.97	50.46	51.95	53.45	54.94	56.43	57.93	59.42	60.91
901 to 1200mm	55.28	56.78	58.27	59.76	61.26	62.75	64.24	65.74	67.23

**# 15mm Required for squash fold on 1mm thick material**

### 1.2mm ZINCALUME G300 AM 125

#### BENDS

GIRTH	FLAT	1	2	3	4	5	6	7	8
up to 100mm	10.73	12.52	14.31	16.11	17.90	19.69	21.48	23.27	25.07
101 to 200mm	15.79	17.58	19.37	21.16	22.95	24.75	26.54	28.33	30.12
201 to 300mm	20.84	22.63	24.43	26.22	28.01	29.80	31.59	33.39	35.18
301 to 400mm	25.90	27.69	29.48	31.27	33.06	34.86	36.65	38.44	40.23
401 to 600mm	36.01	37.80	39.59	41.38	43.18	44.97	46.76	48.55	50.34
601 to 900mm	55.72	57.52	59.31	61.10	62.89	64.68	66.48	68.27	70.06
901 to 1200mm	66.34	68.13	69.93	71.72	73.51	75.30	77.09	78.89	80.68

**# 20mm Required for squash fold on 1.2mm thick material**

# GST Exclusive # 1 metre minimum charge per flashing # Squash Fold is 2 bends # Valid from February 2025



# GALVABOND® steel G2

BlueScope Steel GALVABOND® steel range designed for commercial forming and deep drawing applications with optional improved surface quality.

<b>.55mm GALVABOND G2 Z275</b>									
BENDS									
GIRTH	FLAT	1	2	3	4	5	6	7	8
up to 100mm	5.51	6.41	7.30	8.20	9.09	9.99	10.89	11.78	12.68
101 to 200mm	8.18	9.08	9.98	10.87	11.77	12.66	13.56	14.46	15.35
201 to 300mm	10.86	11.75	12.65	13.55	14.44	15.34	16.23	17.13	18.03
301 to 400mm	13.53	14.43	15.32	16.22	17.12	18.01	18.91	19.80	20.70
401 to 600mm	18.88	19.78	20.67	21.57	22.46	23.36	24.26	25.15	26.05
601 to 900mm	25.30	26.19	27.09	27.98	28.88	29.78	30.67	31.57	32.46
901 to 1200mm	34.92	35.82	36.71	37.61	38.50	39.40	40.30	41.19	42.09
1201 to 1500mm*	47.14	48.35	49.56	50.77	51.98	53.19	54.40	55.61	56.82

<b>.8mm GALVABOND G2 Z275</b>									
BENDS									
GIRTH	FLAT	1	2	3	4	5	6	7	8
up to 100mm	7.43	8.62	9.82	11.01	12.21	13.40	14.60	15.79	16.99
101 to 200mm	11.07	12.27	13.46	14.66	15.85	17.05	18.24	19.44	20.63
201 to 300mm	14.72	15.92	17.11	18.30	19.50	20.69	21.89	23.08	24.28
301 to 400mm	18.37	19.56	20.76	21.95	23.15	24.34	25.53	26.73	27.92
401 to 600mm	25.66	26.85	28.05	29.24	30.44	31.63	32.83	34.02	35.22
601 to 900mm	34.41	35.60	36.80	37.99	39.19	40.38	41.58	42.77	43.97
901 to 1200mm	47.53	48.73	49.92	51.12	52.31	53.51	54.70	55.90	57.09
1201 to 1500mm*	64.17	65.78	67.40	69.01	70.62	72.23	73.85	75.46	77.07

<b>1mm GALVABOND G2 Z275</b>									
BENDS									
GIRTH	FLAT	1	2	3	4	5	6	7	8
up to 100mm	9.23	10.72	12.22	13.71	15.20	16.70	18.19	19.68	21.18
101 to 200mm	13.73	15.22	16.72	18.21	19.70	21.20	22.69	24.18	25.68
201 to 300mm	18.23	19.72	21.22	22.71	24.20	25.70	27.19	28.68	30.18
301 to 400mm	22.73	24.22	25.72	27.21	28.70	30.20	31.69	33.18	34.68
401 to 600mm	31.73	33.22	34.72	36.21	37.70	39.20	40.69	42.18	43.68
601 to 900mm	42.53	44.02	45.52	47.01	48.50	50.00	51.49	52.98	54.48
901 to 1200mm	58.73	60.22	61.72	63.21	64.70	66.20	67.69	69.18	70.68
1201 to 1500mm*	79.28	81.30	83.32	85.33	87.35	89.36	91.38	93.40	95.41

# 15mm Required for squash fold on 1mm thick material

\* 1500mm Sheet Generally Available in 2.4 metre and 3.0 metre lengths - Buy in on Request

# GST Exclusive # 1 metre minimum charge per flashing # Squash Fold is 2 bends # Valid from February 2025



# GALVABOND® steel G2

BlueScope Steel GALVABOND® steel range designed for commercial forming and deep drawing applications with optional improved surface quality.

<b>1.2mm GALVABOND G2 Z275</b>									
BENDS									
GIRTH	FLAT	1	2	3	4	5	6	7	8
up to 100mm	11.17	12.96	14.75	16.54	18.34	20.13	21.92	23.71	25.50
101 to 200mm	16.66	18.46	20.25	22.04	23.83	25.62	27.42	29.21	31.00
201 to 300mm	22.16	23.95	25.74	27.53	29.33	31.12	32.91	34.70	36.49
301 to 400mm	27.65	29.44	31.24	33.03	34.82	36.61	38.40	40.20	41.99
401 to 600mm	38.64	40.43	42.22	44.02	45.81	47.60	49.39	51.18	52.98
601 to 900mm	51.83	53.62	55.41	57.20	58.99	60.79	62.58	64.37	66.16
901 to 1200mm	71.60	73.40	75.19	76.98	78.77	80.56	82.36	84.15	85.94
1201 to 1500mm*	96.67	99.09	101.51	103.92	106.34	108.76	111.18	113.60	116.02

# 20mm Required for squash fold on 1.2mm thick material

\* 1500mm Sheet Generally Available in 2.4 metre and 3.0 metre lengths - Buy in on Request

<b>1.6mm GALVABOND G2 Z275</b>									
BENDS									
GIRTH	FLAT	1	2	3	4	5	6	7	8
up to 100mm	14.51	16.90	19.29	21.68	24.07	26.46	28.85	31.24	33.63
101 to 200mm	21.46	23.85	26.24	28.63	31.02	33.41	35.80	38.19	40.58
201 to 300mm	28.41	30.80	33.19	35.58	37.97	40.36	42.75	45.14	47.53
301 to 400mm	35.36	37.75	40.14	42.53	44.92	47.31	49.70	52.09	54.48
401 to 600mm	49.26	51.65	54.04	56.43	58.81	61.20	63.59	65.98	68.37
601 to 900mm	82.61	85.00	87.39	89.78	92.17	94.56	96.95	99.34	101.73
901 to 1200mm	90.95	93.34	95.73	98.12	100.51	102.90	105.28	107.67	110.06
1201 to 1500mm*	122.78	126.01	129.23	132.46	135.68	138.91	142.13	145.36	148.59

# Cannot Squash Fold 1.6mm thick material

\* 1500mm Sheet Generally Available in 2.4 metre and 3.0 metre lengths - Buy in on Request

**## 1.6mm Galvabond Stocked in Coil x 1200 wide and Sheet - 1200 x 3600 ##**

# GST Exclusive # 1 metre minimum charge per flashing # Squash Fold is 2 bends # Valid from February 2025





## GALVABOND® steel G2

BlueScope Steel GALVABOND® steel range designed for commercial forming and deep drawing applications with optional improved surface quality.

2mm GALVABOND G2 Z275									
BENDS									
GIRTH	FLAT	1	2	3	4	5	6	7	8
up to 100mm	18.72	21.71	24.70	27.68	30.67	33.66	36.64	39.63	42.62
101 to 200mm	27.99	30.97	33.96	36.95	39.93	42.92	45.91	48.89	51.88
201 to 300mm	37.25	40.24	43.23	46.21	49.20	52.19	55.17	58.16	61.15
301 to 400mm	46.52	49.50	52.49	55.48	58.46	61.45	64.44	67.42	70.41
401 to 600mm	65.05	68.03	71.02	74.01	76.99	79.98	82.97	85.95	88.94
601 to 900mm	109.52	112.50	115.49	118.48	121.46	124.45	127.44	130.42	133.41
901 to 1200mm	120.63	123.62	126.61	129.59	132.58	135.57	138.55	141.54	144.53

**# 2mm GALVABOND STOCKED IN 1200mm x 3600mm SHEETS #**

**# Cannot Squash Fold 2mm thick material**

3mm GALVABOND G2 Z275									
BENDS									
GIRTH	FLAT	1	2	3	4	5	6	7	8
up to 100mm	27.69	32.17	36.65	41.13	45.61	50.09	54.57	59.05	63.53
101 to 200mm	41.19	45.67	50.15	54.63	59.11	63.59	68.07	72.55	77.03
201 to 300mm	54.69	59.17	63.65	68.13	72.61	77.09	81.57	86.05	90.53
301 to 400mm	68.19	72.67	77.15	81.63	86.11	90.59	95.07	99.55	104.03
401 to 600mm	95.19	99.67	104.15	108.63	113.11	117.59	122.07	126.55	131.03
601 to 900mm	159.99	164.47	168.95	173.43	177.91	182.39	186.87	191.35	195.83
901 to 1200mm	176.19	180.67	185.15	189.63	194.11	198.59	203.07	207.55	212.03

**# 3mm GALVABOND STOCKED IN 1200mm x 3600mm SHEETS #**

**# Cannot Squash Fold 3mm thick material**

# GST Exclusive # 1 metre minimum charge per flashing # Squash Fold is N/A # Valid from February 2025

## FLAT STRAP UP TO 50mm WIDE

	.55mm	.8mm	1mm	1.2mm	1.5mm	2mm	3mm
ZINCALUME	4.94	5.34	6.67	8.01	X	X	X
COLORBOND	5.25	X	7.51	8.94	X	X	X
GALVABOND	5.01	5.47	6.81	8.22	8.91	11.88	15.76
304 STAINLESS	7.44	X	X	13.93	16.50	21.63	31.47
316 STAINLESS	8.36	X	X	16.02	19.06	24.97	36.68
ALUMINIUM	X	X	7.17	X	X	X	X

## Extra Bends - Flashings

## For Each additional Bend after 8 bends

Material Thickness	Per Bend & Per Metre
.55mm	0.90
.8mm	1.19
1.0mm	1.49
1.2mm	1.79
1.6mm	2.39
2.0mm	2.99
3.0mm	4.48

# GST Exclusive # 1 metre minimum charge per flashing # Valid from February 2025

# Stainless Steel

---

STOCK MATERIAL on Coil 1200 Wide - .55mm

---

304 2b

316 2b

---

STOCK MATERIAL on Coil 1200 Wide - 1.2mm

---

304 No 4

316 No 4

---

STOCK MATERIAL on Coil 1200 Wide - 1.5mm

---

304 No 4

316 No 4

# Aluminium

---

STOCK MATERIAL on Coil 1200 Wide - 1mm

---

5005 grade Mill finish

# Stainless Steel - Stock Flashing Feed

<b>.55mm 304 2b GRADE STAINLESS STEEL</b>									
BENDS									
GIRTH	FLAT	1	2	3	4	5	6	7	8
up to 100mm	10.62	11.51	12.41	13.30	14.20	15.10	15.99	16.89	17.78
101 to 200mm	18.39	19.29	20.18	21.08	21.98	22.87	23.77	24.66	25.56
201 to 300mm	26.17	27.07	27.96	28.86	29.75	30.65	31.55	32.44	33.34
301 to 400mm	33.95	34.84	35.74	36.64	37.53	38.43	39.32	40.22	41.12
401 to 600mm	49.50	50.40	51.30	52.19	53.09	53.98	54.88	55.78	56.67
601 to 900mm	79.84	80.73	81.63	82.53	83.42	84.32	85.21	86.11	87.01
901 to 1200mm	96.17	97.07	97.96	98.86	99.75	100.65	101.55	102.44	103.34

<b>.55mm 316 2b GRADE STAINLESS STEEL</b>									
BENDS									
GIRTH	FLAT	1	2	3	4	5	6	7	8
up to 100mm	12.56	13.46	14.35	15.25	16.14	17.04	17.94	18.83	19.73
101 to 200mm	22.28	23.18	24.07	24.97	25.87	26.76	27.66	28.55	29.45
201 to 300mm	32.00	32.90	33.80	34.69	35.59	36.48	37.38	38.28	39.17
301 to 400mm	41.73	42.62	43.52	44.41	45.31	46.21	47.10	48.00	48.89
401 to 600mm	61.17	62.07	62.96	63.86	64.75	65.65	66.55	67.44	68.34
601 to 900mm	105.50	106.40	107.30	108.19	109.09	109.98	110.88	111.78	112.67
901 to 1200mm	119.50	120.40	121.30	122.19	123.09	123.98	124.88	125.78	126.67

<b>1.2mm 304 GRADE STAINLESS STEEL</b>									
BENDS									
GIRTH	FLAT	1	2	3	4	5	6	7	8
up to 100mm	23.17	24.97	26.76	28.55	30.34	32.13	33.93	35.72	37.51
101 to 200mm	40.67	42.47	44.26	46.05	47.84	49.63	51.43	53.22	55.01
201 to 300mm	58.17	59.97	61.76	63.55	65.34	67.13	68.93	70.72	72.51
301 to 400mm	75.67	77.47	79.26	81.05	82.84	84.63	86.43	88.22	90.01
401 to 600mm	110.67	112.47	114.26	116.05	117.84	119.63	121.43	123.22	125.01
601 to 900mm	184.17	185.97	187.76	189.55	191.34	193.13	194.93	196.72	198.51
901 to 1200mm	205.67	207.47	209.26	211.05	212.84	214.63	216.43	218.22	220.01

<b>1.2mm 316 GRADE STAINLESS STEEL</b>									
BENDS									
GIRTH	FLAT	1	2	3	4	5	6	7	8
up to 100mm	27.55	29.34	31.13	32.93	34.72	36.51	38.30	40.09	41.89
101 to 200mm	49.42	51.22	53.01	54.80	56.59	58.38	60.18	61.97	63.76
201 to 300mm	71.30	73.09	74.88	76.68	78.47	80.26	82.05	83.84	85.64
301 to 400mm	93.17	94.97	96.76	98.55	100.34	102.13	103.93	105.72	107.51
401 to 600mm	136.92	138.72	140.51	142.30	144.09	145.88	147.68	149.47	151.26
601 to 900mm	224.42	226.22	228.01	229.80	231.59	233.38	235.18	236.97	238.76
901 to 1200mm	255.67	257.47	259.26	261.05	262.84	264.63	266.43	268.22	270.01

# GST Exclusive # 1 metre minimum charge per flashing # Squash Fold is 2 bends # Valid from February 2025

# 20mm Required for squash fold on 1.2mm thick material

# Stainless Steel - Stock Flashing Feed

<b>1.5mm 304 GRADE STAINLESS STEEL</b>									
BENDS									
GIRTH	FLAT	1	2	3	4	5	6	7	8
up to 100mm	28.11	30.35	32.59	34.83	37.07	39.31	41.55	43.79	46.03
101 to 200mm	50.99	53.23	55.47	57.71	59.95	62.19	64.43	66.67	68.91
201 to 300mm	73.88	76.12	78.36	80.60	82.84	85.08	87.32	89.56	91.80
301 to 400mm	96.76	99.00	101.24	103.48	105.72	107.96	110.20	112.44	114.68
401 to 600mm	142.53	144.77	147.01	149.25	151.49	153.73	155.97	158.21	160.45
601 to 900mm	245.51	247.75	249.99	252.23	254.47	256.71	258.95	261.19	263.43
901 to 1200mm	266.76	269.00	271.24	273.48	275.72	277.96	280.20	282.44	284.68
1201 to 1500mm*	360.13	363.15	366.18	369.20	372.23	375.25	378.27	381.30	384.32

\* 1500mm Sheet Generally Available in 2.4 metre and 3.0 metre lengths - Buy in on Request

<b>1.5mm 316 GRADE STAINLESS STEEL</b>									
BENDS									
GIRTH	FLAT	1	2	3	4	5	6	7	8
up to 100mm	33.49	35.73	37.97	40.21	42.45	44.69	46.93	49.17	51.41
101 to 200mm	61.76	64.00	66.24	68.48	70.72	72.96	75.20	77.44	79.68
201 to 300mm	90.03	92.27	94.51	96.75	98.99	101.23	103.47	105.71	107.95
301 to 400mm	118.30	120.54	122.78	125.02	127.26	129.50	131.74	133.98	136.22
401 to 600mm	174.84	177.08	179.32	181.56	183.80	186.04	188.28	190.52	192.76
601 to 900mm	303.75	305.99	308.23	310.47	312.71	314.95	317.19	319.43	321.67
901 to 1200mm	344.45	346.69	348.93	351.17	353.41	355.65	357.89	360.13	362.37
1201 to 1500mm*	465.01	468.04	471.06	474.09	477.11	480.13	483.16	486.18	489.21

\* 1500mm Sheet Generally Available in 2.4 metre and 3.0 metre lengths - Buy in on Request

# GST Exclusive # 1 metre minimum charge per flashing # Squash Fold is N/A # Valid from February 2025

# Cannot Squash Fold 1.6mm thick material

# Stainless Steel - Heavy Guage on Sheet

**STAINLESS STEEL IN SHEET FORM - Usually 2.4, 3.0 or 3.6 Metre - NOT STOCK**

## 2mm 304 GRADE STAINLESS STEEL

### BENDS

GIRTH	FLAT	1	2	3	4	5	6	7	8
up to 200mm	75.88	78.86	81.85	84.84	87.82	90.81	93.80	96.78	99.77
201 to 400mm	123.48	126.46	129.45	132.44	135.42	138.41	141.40	144.38	147.37
401 to 600mm	182.98	185.96	188.95	191.94	194.92	197.91	200.90	203.88	206.87
601 to 900mm	316.85	319.84	322.83	325.81	328.80	331.79	334.77	337.76	340.75
901 to 1200mm	361.48	364.46	367.45	370.44	373.42	376.41	379.40	382.38	385.37
1201 to 1500mm*	487.99	492.03	496.06	500.09	504.12	508.15	512.19	516.22	520.25

\* 1500mm Sheet Generally Available in 2.4 metre and 3.0 metre lengths - Buy in on Request

## 2mm 316 GRADE STAINLESS STEEL

### BENDS

GIRTH	FLAT	1	2	3	4	5	6	7	8
up to 200mm	77.98	80.96	83.95	86.94	89.92	92.91	95.90	98.88	101.87
201 to 400mm	151.48	154.46	157.45	160.44	163.42	166.41	169.40	172.38	175.37
401 to 600mm	224.98	227.96	230.95	233.94	236.92	239.91	242.90	245.88	248.87
601 to 900mm	401.38	404.36	407.35	410.34	413.32	416.31	419.30	422.28	425.27
901 to 1200mm	445.48	448.46	451.45	454.44	457.42	460.41	463.40	466.38	469.37
1201 to 1500mm*	601.39	605.43	609.46	613.49	617.52	621.55	625.59	629.62	633.65

\* 1500mm Sheet Generally Available in 2.4 metre and 3.0 metre lengths - Buy in on Request

# GST Exclusive # 1 metre mininum charge per flashing # Squash Fold is N/A # Valid from February 2025

**# Cannot Squash Fold 2mm thick material**



# Stainless Steel - Heavy Guage on Sheet

**STAINLESS STEEL IN SHEET FORM - Usually 2.4, 3.0 or 3.6 Metre - NOT STOCK**

## 3mm 304 GRADE STAINLESS STEEL

### BENDS

GIRTH	FLAT	1	2	3	4	5	6	7	8
up to 200mm	95.95	100.43	104.91	109.39	113.87	118.35	122.83	127.31	131.79
201 to 400mm	188.92	193.40	197.88	202.36	206.84	211.32	215.80	220.28	224.76
401 to 600mm	281.89	286.37	290.85	295.33	299.81	304.29	308.77	313.25	317.73
601 to 900mm	491.07	495.55	500.03	504.51	508.99	513.47	517.95	522.43	526.91
901 to 1200mm	560.80	565.28	569.76	574.24	578.72	583.20	587.68	592.16	596.64
1201 to 1500mm*	757.08	763.12	769.17	775.22	781.27	787.32	793.36	799.41	805.46

\* 1500mm Sheet Generally Available in 2.4 metre and 3.0 metre lengths - Buy in on Request

## 3mm 316 GRADE STAINLESS STEEL

### BENDS

GIRTH	FLAT	1	2	3	4	5	6	7	8
up to 200mm	117.83	122.31	126.79	131.27	135.75	140.23	144.71	149.19	153.67
201 to 400mm	232.67	237.15	241.63	246.11	250.59	255.07	259.55	264.03	268.51
401 to 600mm	347.52	352.00	356.48	360.96	365.44	369.92	374.40	378.88	383.36
601 to 900mm	623.14	627.62	632.10	636.58	641.06	645.54	650.02	654.50	658.98
901 to 1200mm	692.05	696.53	701.01	705.49	709.97	714.45	718.93	723.41	727.89
1201 to 1500mm*	934.26	940.31	946.36	952.41	958.45	964.50	970.55	976.60	982.65

\* 1500mm Sheet Generally Available in 2.4 metre and 3.0 metre lengths - Buy in on Request

# GST Exclusive # 1 metre mininum charge per flashing # Squash Fold is N/A # Valid from February 2025

**# Cannot Squash Fold 3mm thick material**

**1mm ALUMINIUM MILL FINISH 5005 GRADE - STOCKED ON 1200mm WIDE COIL**

**BENDS**

GIRTH	FLAT	1	2	3	4	5	6	7	8
up to 100mm	9.98	11.47	12.97	14.46	15.95	17.45	18.94	20.43	21.93
101 to 200mm	15.23	16.72	18.22	19.71	21.20	22.70	24.19	25.68	27.18
201 to 300mm	20.48	21.97	23.47	24.96	26.45	27.95	29.44	30.93	32.43
301 to 400mm	25.73	27.22	28.72	30.21	31.70	33.20	34.69	36.18	37.68
401 to 600mm	36.23	37.72	39.22	40.71	42.20	43.70	45.19	46.68	48.18
601 to 900mm	59.85	61.35	62.84	64.33	65.83	67.32	68.81	70.31	71.80
901 to 1200mm	67.73	69.22	70.72	72.21	73.70	75.20	76.69	78.18	79.68

**ALUMINIUM IN SHEET FORM - Usually 2.4, 3.0 or 3.6 Metre - NOT STOCKED**

**1.6mm ALUMINIUM MILL FINISH 5005 GRADE - SHEET BUY IN**

**BENDS**

GIRTH	FLAT	1	2	3	4	5	6	7	8
up to 200mm	24.37	26.76	29.14	31.53	33.92	36.31	38.70	41.09	43.48
201 to 400mm	41.17	43.56	45.94	48.33	50.72	53.11	55.50	57.89	60.28
401 to 600mm	57.97	60.36	62.74	65.13	67.52	69.91	72.30	74.69	77.08
601 to 900mm	95.77	98.16	100.54	102.93	105.32	107.71	110.10	112.49	114.88
901 to 1200mm	108.37	110.76	113.14	115.53	117.92	120.31	122.70	125.09	127.48
1201 to 1500mm	146.29	149.52	152.75	155.97	159.20	162.42	165.65	168.87	172.10

**2mm ALUMINIUM MILL FINISH 5005 GRADE - SHEET BUY IN**

**BENDS**

GIRTH	FLAT	1	2	3	4	5	6	7	8
up to 200mm	30.46	33.44	36.43	39.42	42.40	45.39	48.38	51.36	54.35
201 to 400mm	51.46	54.44	57.43	60.42	63.40	66.39	69.38	72.36	75.35
401 to 600mm	72.46	75.44	78.43	81.42	84.40	87.39	90.38	93.36	96.35
601 to 900mm	119.71	122.69	125.68	128.67	131.65	134.64	137.63	140.61	143.60
901 to 1200mm	135.46	138.44	141.43	144.42	147.40	150.39	153.38	156.36	159.35
1201 to 1500mm	182.87	186.90	190.93	194.96	199.00	203.03	207.06	211.09	215.12

**3mm ALUMINIUM MILL FINISH 5005 GRADE - SHEET BUY IN**

**BENDS**

GIRTH	FLAT	1	2	3	4	5	6	7	8
up to 200mm	45.69	50.17	54.65	59.13	63.61	68.09	72.57	77.05	81.53
201 to 400mm	77.19	81.67	86.15	90.63	95.11	99.59	104.07	108.55	113.03
401 to 600mm	108.69	113.17	117.65	122.13	126.61	131.09	135.57	140.05	144.53
601 to 900mm	179.56	184.04	188.52	193.00	197.48	201.96	206.44	210.92	215.40
901 to 1200mm	203.19	207.67	212.15	216.63	221.11	225.59	230.07	234.55	239.03
1201 to 1500mm	274.30	280.35	286.40	292.45	298.49	304.54	310.59	316.64	322.69

# GST Exclusive # 1 metre minimum charge per flashing # Squash Fold 1mm Only # Valid from February 2025

# Commercial Gutter Range

---

## 6 Metre Smooth Rolled Range

---

Half Round Gutter

OG Style Gutter (Recommended 4 metre maximum)

Quad Style Gutter

---

## 8 Metre Folded Range

---

High Front Slotted

Low Front Unslotted

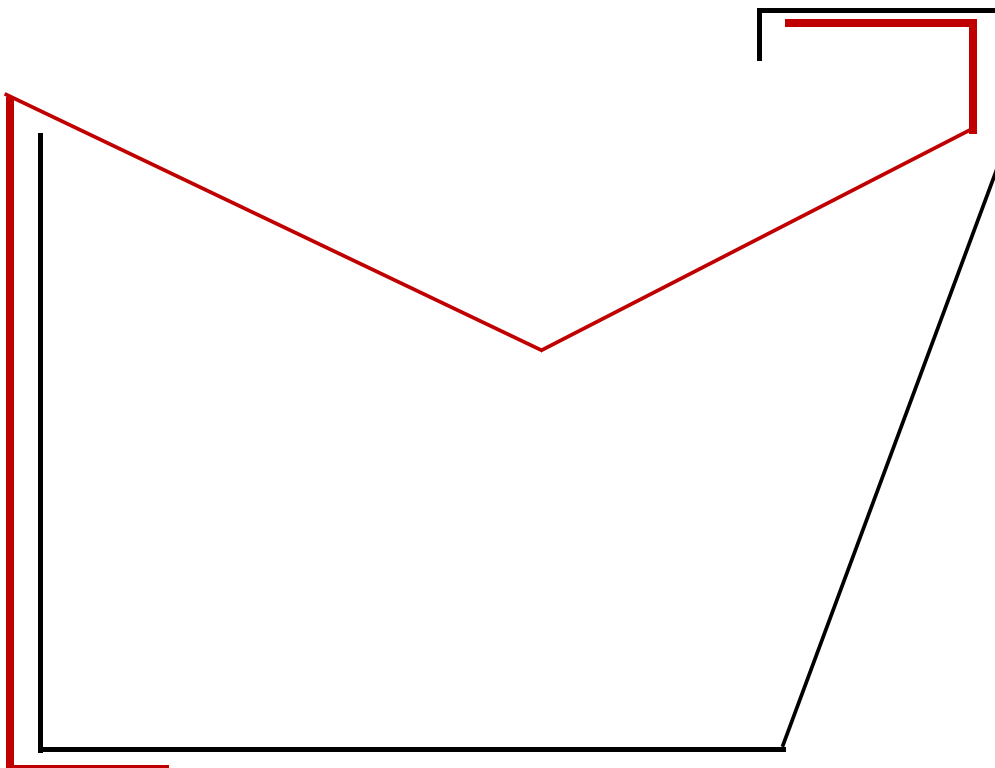

## Gutter Range - General Lead Time Guide

Item	Next Day Availability	48 Hour Availability	Other (Working Days)
<b>Half Round Gutter</b>	On Request	✓	
Powder Coated Brackets	X	X	5 - 6 days
Stop Ends	On Request	✓	
Drops	On Request	✓	
<b>OG Style Gutter</b>	X	X	3 days
Concealed Brackets	X	X	3 days
Stop Ends	X	X	3 days
<b>High Front Slotted Eaves Gutter</b>	X	✓	
Concealed Brackets	X	✓	
Stop Ends	X	✓	
Powder Coated External Bracket	X	X	7 days
<b>Low Front Unslotted Eaves Gutter</b>	X	✓	
Concealed Brackets	X	✓	
Stop Ends	X	✓	
Powder Coated external Brackets	X	X	7 days
<b>Quad Style Gutter</b>	X	✓	
Stop Ends	X	✓	
Powder Coated external Brackets	X	X	7 days

**## Next Day Availability - May Be Possible if Order Placed prior to 10am ##**

## Gutter Range - Quick Info Guide

<b>Half Round Gutter</b>	<b>Capacity (mm<sup>2</sup>)</b>	<b>.55 Std Colorbond - per lineal metre</b>	<b>Powder Coated Bracket to Suit</b>	
150mm	7 300	\$19.38	\$25.30	3mm Aluminium
175mm	10 500	\$23.23	\$28.00	3mm Aluminium
200mm	13 700	\$24.16	\$30.87	3mm Aluminium
225mm	17 600	\$26.96	\$35.54	3mm Aluminium
250mm	22 000	\$31.33	\$38.84	3mm Aluminium
300mm	32 300	\$35.02	\$45.30	3mm Aluminium
350mm	44 600	\$38.71	\$63.34	3mm Aluminium
400mm	58 800	\$49.73	\$81.40	4mm Aluminium
450mm	75 000	\$58.93	\$94.49	4mm Aluminium
<b>High Front Slotted Eaves Gutter</b>	<b>Capacity (mm<sup>2</sup>)</b>	<b>.55 Std Colorbond - per lineal metre</b>	<b>Concealed Bracket to Suit</b>	
400 girth	10 500	\$23.50	\$10.41	3mm Galvabond
600 girth	27 500	\$28.97	\$11.70	3mm Galvabond
800 girth	42 500	\$37.53	\$19.55	4mm Duragal
1000 girth	65 000	\$44.51	\$25.94	5mm Duragal
1200 girth		\$47.66	\$37.20	6mm Duragal
* Pricing applies to the Standard Eaves Gutter Sizes				
<b>Low Front Unslotted Eaves Gutter</b>	<b>Capacity (mm<sup>2</sup>)</b>	<b>.55 Std Colorbond - per lineal metre</b>	<b>Concealed Bracket to Suit</b>	
400 girth	12 000	\$20.50	\$10.41	3mm Galvabond
600 girth	35 000	\$25.07	\$16.04	4mm Duragal
800 girth	60 000	\$33.64	\$22.18	5mm Duragal
1000 girth	70 000	\$40.61	\$31.00	6mm Duragal
1200 girth		\$43.76	\$37.20	6mm Duragal
* Pricing applies to the Standard Eaves Gutter Sizes				
<b>OG Style - slotted</b>	<b>Capacity (mm<sup>2</sup>)</b>	<b>.55 Std Colorbond - per lineal metre</b>	<b>Concealed Bracket to Suit</b>	
450 girth	12 000	\$34.33	\$10.41	3mm Galvabond
600 girth	22 550	\$38.02	\$11.70	3mm Galvabond
<b>OG Style - unslotted</b>	<b>Capacity (mm<sup>2</sup>)</b>	<b>.55 Std Colorbond - per lineal metre</b>	<b>Concealed Bracket to Suit</b>	
450 girth	16 500	\$31.33	\$10.41	3mm Galvabond
600 girth	28 700	\$35.02	\$11.70	3mm Galvabond

# Half Round Gutters

# Smooth Rolled Up to 6 metres length

# Bead is 12mm Higher than Back of Gutter

# Rolled Bead Front as Standard

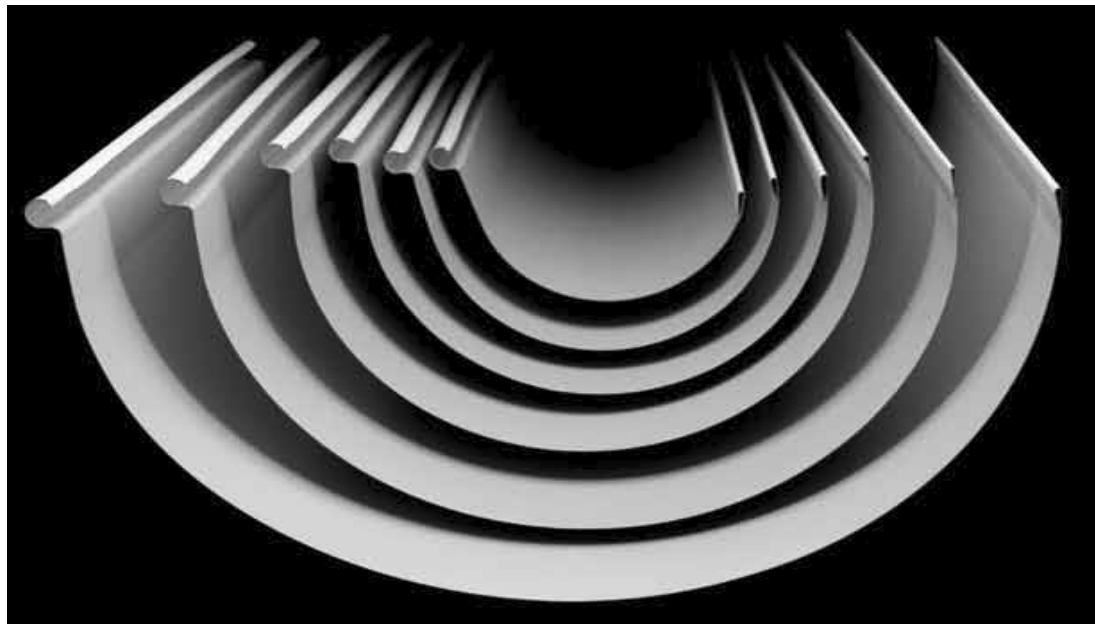

Gutter Capacity		Dimensions (mm)		
Gutter Diam	Effective Cross-Sectional Area (mm <sup>2</sup> )	Front Height to Bead	Depth of Gutter	Height at Back of Gutter
150	7 300	87	75	75
175	10 500	101	89	89
200	13 700	112	100	100
225	17 600	124	112	112
250	22 000	137	125	125
300	32 300	162	150	150
350	44 600	187	175	175
400	58 800	212	200	200
450	75 000	237	225	225



Aluminium Powder Coated Laser Cut Brackets

**Standard Lead time is 7 Working Days\***

\* Refer to Current Stock on hand / Otherwise 12 Working Days



# Half Round Brackets - Information

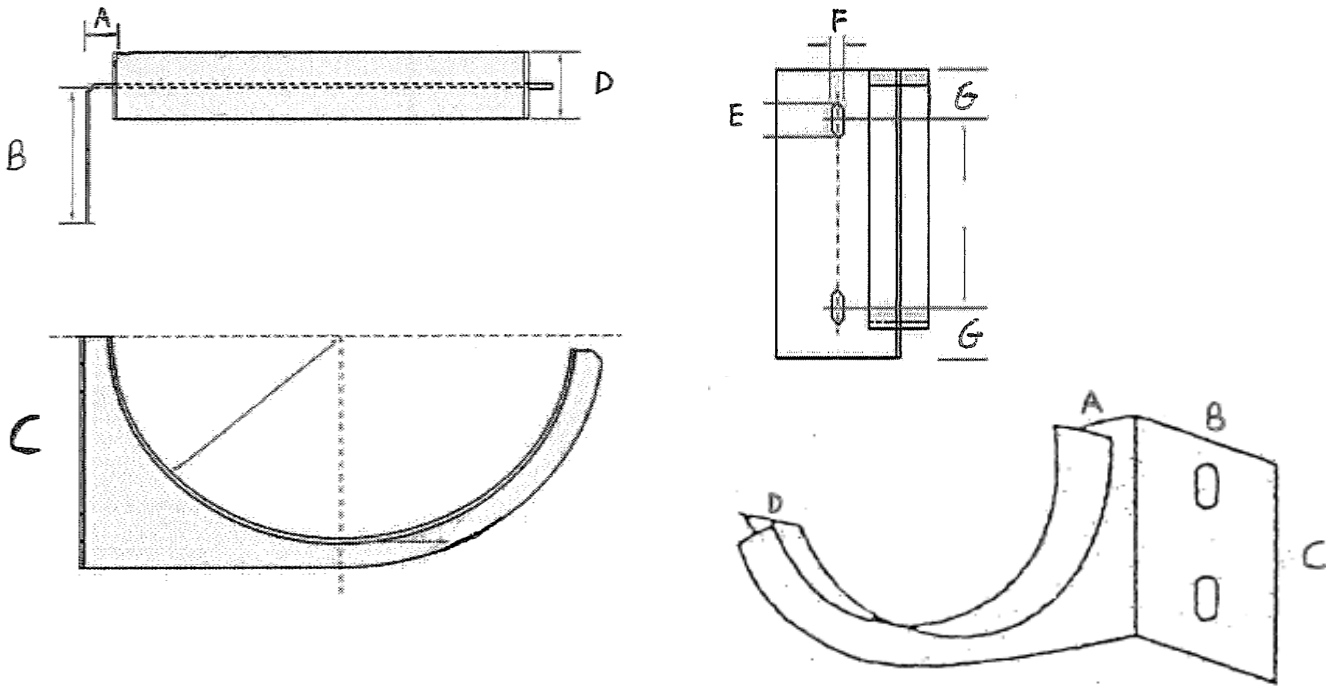

**A** Wall Stand Off  
**B** Width of Back Plate  
**C** Height of Back Plate

**D** Band Width  
**E / F** Slot Size  
**G** Slot Centre

		Bracket Dimensions (mm)					
Gutter Diam	Gutter Depth	A	B	C	D	E/F	G
150mm	75mm	14	80	95	25	20 x 8	30
175mm	88mm	14	80	107	40	20 x 8	30
200mm	100mm	14	80	120	40	20 x 8	30
225mm	113mm	14	80	133	40	20 x 8	30
250mm	125mm	14	80	145	40	20 x 8	30
300mm	150mm	14	80	170	40	20 x 8	30
350mm	175mm	14	80	200	40	20 x 8	40
400mm	200mm	24	100	228	40	25 x 12	40
450mm	225mm	24	100	253	40	25 x 12	40

		Bracket Thickness		
Gutter Diam	Aluminium	Stainless Steel	Galvabond	
150mm	3mm	2mm	2mm	
175mm	3mm	2mm	2mm	
200mm	3mm	2mm	2mm	
225mm	3mm	2mm	2mm	
250mm	3mm	2mm	2mm	
300mm	3mm	2mm	2mm	
350mm	3mm	2mm	2mm	
400mm	4mm	3mm	3mm	
450mm	4mm	3mm	3mm	

# Half Round Brackets - Information

## Stand Off From Wall - Top View of Bracket

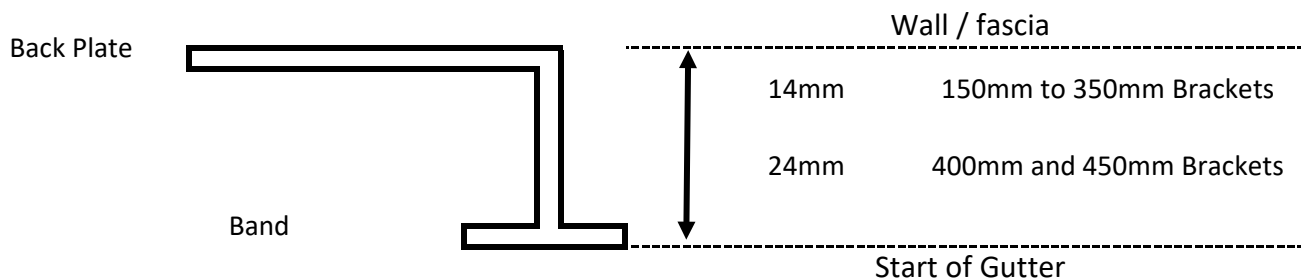

## Standard Bracket Lead Times - Working Days

Gutter Diam	Aluminium	Stainless Steel	Galvabond
150mm	7	7	12
175mm	7	12	12
200mm	7	7	12
225mm	7	12	12
250mm	7	7	12
300mm	7	7	12
350mm	7	12	12
400mm	7	12	12
450mm	7	12	12

## Standard Bracket Parts we Usually Stock

Gutter Diam	Aluminium (Powder Coated)	Stainless Steel (2b mill finish)	Galvabond (plain)
150mm	500 +	100	Nil
175mm	500 +	100	Nil
200mm	500 +	100	Nil
225mm	500 +	100	Nil
250mm	500 +	100	Nil
300mm	500 +	100	Nil
350mm	500 +	100	Nil
400mm	150	nil	Nil
450mm	100	nil	Nil

## Non - Standard Bracket - Pitched Brackets

Lead time is 15 working days (3 weeks)

# Half Round Brackets - Information

---

New Style Brackets - Hook at Back / Gutter Stopper

Now Standard for Sizes 150mm to 350mm

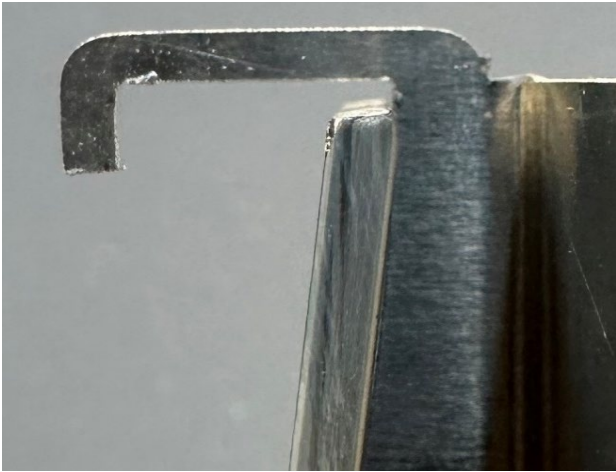

# Half Round Gutters

# Smooth Rolled Up to 6 metres length

# Rolled Bead Front as Standard

# Squash Fold at back

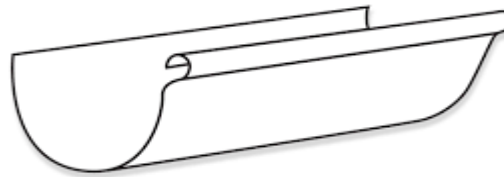

## .55mm Material - Price per lineal Metre

Diam	C/bond	Zinc	Gal	Ultra	Metallic	304 2b	316 2b	Matt	
150mm	\$19.38	\$18.42	\$18.84	\$24.49	\$28.01	\$33.42	\$38.98	\$22.93	
175mm	\$23.23	\$21.67	\$22.22	\$29.68	\$34.32	\$41.47	\$48.80	\$27.62	
200mm	\$24.16	\$22.60	\$23.15	\$30.61	\$35.25	\$42.40	\$49.73	\$28.55	
225mm	\$26.96	\$24.47	\$25.02	\$32.48	\$37.12	\$44.27	\$51.60	\$30.42	
250mm	\$31.33	\$29.38	\$30.21	\$41.52	\$48.54	\$59.38	\$70.49	\$38.40	
300mm	\$35.02	\$31.24	\$32.08	\$43.38	\$50.41	\$61.24	\$72.36	\$40.27	
350mm	\$38.71	\$34.56	\$35.47	\$47.91	\$55.64	\$67.56	\$79.78	\$44.48	
400mm	\$49.73	\$44.07	\$45.32	\$62.28	\$72.82	\$89.07	\$105.73	\$57.60	
450mm	\$58.93	\$52.13	\$53.63	\$73.98	\$86.63	\$106.13	\$126.13	\$68.37	



## Laser Cut Brackets

Diam	Aluminium + Powder Coated					Stainless		Uncoated	
	C/bond	Zinc	Ultra	Metallic	Matt	304 2b	316 2b	Gal	Ali
150mm	\$25.30	\$27.30	\$25.30	\$30.30	\$25.30	\$39.46	\$46.66	\$27.30	\$20.30
175mm	\$28.00	\$30.00	\$28.00	\$33.00	\$28.00	\$43.37	\$51.59	\$30.00	\$22.40
200mm	\$30.87	\$32.87	\$30.87	\$35.87	\$30.87	\$48.32	\$57.96	\$32.87	\$24.27
225mm	\$35.54	\$37.54	\$35.54	\$40.54	\$35.54	\$55.96	\$67.53	\$37.54	\$28.84
250mm	\$38.84	\$40.84	\$38.84	\$43.84	\$38.84	\$61.91	\$75.08	\$40.84	\$31.04
300mm	\$45.30	\$47.30	\$45.30	\$50.30	\$45.30	\$72.51	\$88.17	\$47.30	\$36.50
350mm	\$63.34	\$65.34	\$63.34	\$68.34	\$63.34	\$87.66	\$107.20	\$65.34	\$51.34
400mm	\$81.40	\$83.40	\$81.40	\$86.40	\$81.40	\$118.66	\$146.28	\$83.40	\$67.80
450mm	\$94.49	\$96.49	\$94.49	\$99.49	\$94.49	\$148.74	\$183.79	\$96.49	\$78.89

<b>Brackets - Small Order Powder Coating Surcharge</b>	<b>\$60.00</b>
--	----------------

Diam	150mm to 225mm	Orders less than 15 Brackets
Diam	250mm to 300mm	Orders less than 12 Brackets
Diam	350mm to 450mm	Orders less than 8 brackets

Standard Lead Times

Gutter & Accessories

2 Working days

Coated Brackets

7 Working days ( 1.5 week)

Plain Brackets

2 Working days

# Half Round Gutters

## Corners - .55mm Material - Price per each

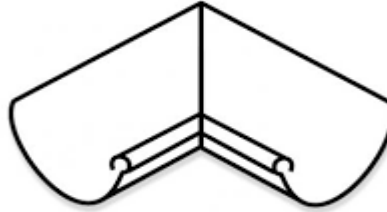
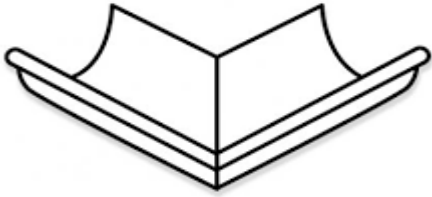

Diam	C/bond	Zinc	Gal	Ultra	Metallic	304 2b	316 2b	Matt	
150mm	\$75.38	\$74.42	\$74.84	\$80.49	\$84.01	\$89.42	\$94.98	\$78.93	
175mm	\$83.23	\$81.67	\$82.22	\$89.68	\$94.32	\$101.47	\$108.80	\$87.62	
200mm	\$86.16	\$84.60	\$85.15	\$92.61	\$97.25	\$104.40	\$111.73	\$90.55	
225mm	\$91.96	\$89.47	\$90.02	\$97.48	\$102.12	\$109.27	\$116.60	\$95.42	
250mm	\$99.33	\$97.38	\$98.21	\$109.52	\$116.54	\$127.38	\$138.49	\$106.40	
300mm	\$110.02	\$106.24	\$107.08	\$118.38	\$125.41	\$136.24	\$147.36	\$115.27	
350mm	\$118.71	\$114.56	\$115.47	\$127.91	\$135.64	\$147.56	\$159.78	\$124.48	
400mm	\$135.73	\$130.07	\$131.32	\$148.28	\$158.82	\$175.07	\$191.73	\$143.60	
450mm	\$150.93	\$144.13	\$145.63	\$165.98	\$178.63	\$198.13	\$218.13	\$160.37	

## Stop Ends - .55mm Material - Price per each



Diam	C/bond	Zinc	Gal	Ultra	Metallic	304 2b	316 2b	Matt	
150mm	\$20.49	\$20.11	\$20.19	\$21.33	\$22.03	\$23.11	\$24.22	\$21.01	
175mm	\$22.36	\$21.98	\$22.06	\$23.19	\$23.89	\$24.98	\$26.09	\$22.88	
200mm	\$24.22	\$23.84	\$23.93	\$25.06	\$25.76	\$26.84	\$27.96	\$24.75	
225mm	\$26.82	\$26.29	\$26.41	\$27.99	\$28.97	\$30.49	\$32.04	\$27.55	
250mm	\$29.05	\$28.44	\$28.58	\$30.39	\$31.51	\$33.24	\$35.02	\$29.89	
300mm	\$33.51	\$32.76	\$32.92	\$35.18	\$36.59	\$38.76	\$40.98	\$34.56	
350mm	\$39.07	\$37.93	\$38.18	\$41.58	\$43.68	\$46.93	\$50.27	\$40.64	
400mm	\$44.62	\$43.11	\$43.44	\$47.97	\$50.78	\$55.11	\$59.56	\$46.72	
450mm	\$46.44	\$44.56	\$44.97	\$50.63	\$54.14	\$59.56	\$65.11	\$49.07	

## Sculptured drop to suit - .55mm Material - price per each



Diam	C/bond	Zinc	Gal	Ultra	Metallic	304 2b	316 2b	Matt	
90mm	\$24.22	\$23.84	\$23.93	\$25.06	\$25.76	\$26.84	\$27.96	\$24.75	
100mm	\$27.96	\$27.58	\$27.66	\$28.79	\$29.49	\$30.58	\$31.69	\$28.48	
125mm	\$30.92	\$30.31	\$30.44	\$32.25	\$33.38	\$35.11	\$36.89	\$31.75	
150mm	\$32.78	\$32.18	\$32.31	\$34.12	\$35.24	\$36.98	\$38.76	\$33.62	
225mm	\$37.24	\$36.49	\$36.66	\$38.92	\$40.32	\$42.49	\$44.71	\$38.29	
300mm	\$42.80	\$41.67	\$41.92	\$45.31	\$47.42	\$50.67	\$54.00	\$44.37	

# Half Round Flat Back Gutters

# Smooth Rolled Up to 6 metres length

# Rolled Bead Front as Standard

Half Round Flat Back Gutter

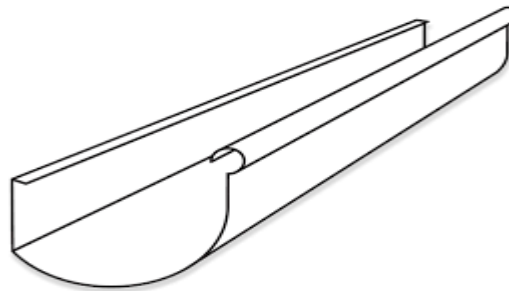

## .55mm Material - Price per lineal Metre

Diam	C/bond	Zinc	Gal	Ultra	Metallic	304 2b	316 2b	Matt	
150mm	\$19.38	\$18.42	\$18.84	\$24.49	\$28.01	\$33.42	\$38.98	\$22.93	
175mm	\$23.23	\$21.67	\$22.22	\$29.68	\$34.32	\$41.47	\$48.80	\$27.62	
200mm	\$24.16	\$22.60	\$23.15	\$30.61	\$35.25	\$42.40	\$49.73	\$28.55	
225mm	\$26.96	\$24.47	\$25.02	\$32.48	\$37.12	\$44.27	\$51.60	\$30.42	
250mm	\$31.33	\$29.38	\$30.21	\$41.52	\$48.54	\$59.38	\$70.49	\$38.40	
300mm	\$35.02	\$31.24	\$32.08	\$43.38	\$50.41	\$61.24	\$72.36	\$40.27	
350mm	\$38.71	\$34.56	\$35.47	\$47.91	\$55.64	\$67.56	\$79.78	\$44.48	
400mm	\$49.73	\$44.07	\$45.32	\$62.28	\$72.82	\$89.07	\$105.73	\$57.60	
450mm	\$58.93	\$52.13	\$53.63	\$73.98	\$86.63	\$106.13	\$126.13	\$68.37	

## Laser Cut A4 Style Brackets

Diam	Powder Coated		Plain	Powder Coated		Stainless Steel		P/C	Plain
	C/bond	Zinc	Gal	Ultra	Metallic	304 2b	316 2b	Matt	Ali
150mm	\$25.30	\$27.30	\$27.30	\$25.30	\$30.30	\$39.46	\$46.66	\$25.30	\$20.30
175mm	\$28.00	\$30.00	\$30.00	\$28.00	\$33.00	\$43.37	\$51.59	\$28.00	\$22.40
200mm	\$30.87	\$32.87	\$32.87	\$30.87	\$35.87	\$48.32	\$57.96	\$30.87	\$24.27
225mm	\$35.54	\$37.54	\$37.54	\$35.54	\$40.54	\$55.96	\$67.53	\$35.54	\$28.84
250mm	\$38.84	\$40.84	\$40.84	\$38.84	\$43.84	\$61.91	\$75.08	\$38.84	\$31.04
300mm	\$45.30	\$47.30	\$47.30	\$45.30	\$50.30	\$72.51	\$88.17	\$45.30	\$36.50
350mm	\$63.34	\$65.34	\$65.34	\$63.34	\$68.34	\$87.66	\$107.20	\$63.34	\$51.34
400mm	\$81.40	\$83.40	\$83.40	\$81.40	\$86.40	\$118.66	\$146.28	\$81.40	\$67.80
450mm	\$94.49	\$96.49	\$96.49	\$94.49	\$99.49	\$148.74	\$183.79	\$94.49	\$78.89

## Bracket Lead time

150mm

7 Working Days

All Other Sizes

15 Working Days

# Flat Back Half Round Gutters

## Corners - .55mm Material - Price per each

Diam	C/bond	Zinc	Gal	Ultra	Metallic	304 2b	316 2b	Matt	
150mm	\$75.38	\$74.42	\$74.84	\$80.49	\$84.01	\$89.42	\$94.98	\$78.93	
175mm	\$83.23	\$81.67	\$82.22	\$89.68	\$94.32	\$101.47	\$108.80	\$87.62	
200mm	\$86.16	\$84.60	\$85.15	\$92.61	\$97.25	\$104.40	\$111.73	\$90.55	
225mm	\$91.96	\$89.47	\$90.02	\$97.48	\$102.12	\$109.27	\$116.60	\$95.42	
250mm	\$99.33	\$97.38	\$98.21	\$109.52	\$116.54	\$127.38	\$138.49	\$106.40	
300mm	\$110.02	\$106.24	\$107.08	\$118.38	\$125.41	\$136.24	\$147.36	\$115.27	
350mm	\$118.71	\$114.56	\$115.47	\$127.91	\$135.64	\$147.56	\$159.78	\$124.48	
400mm	\$135.73	\$130.07	\$131.32	\$148.28	\$158.82	\$175.07	\$191.73	\$143.60	
450mm	\$150.93	\$144.13	\$145.63	\$165.98	\$178.63	\$198.13	\$218.13	\$160.37	

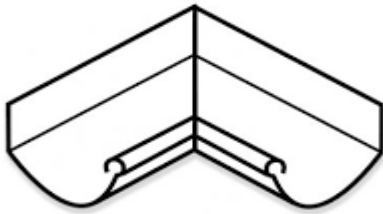

## Stop Ends - .55mm Material - Price per each

Diam	C/bond	Zinc	Gal	Ultra	Metallic	304 2b	316 2b	Matt	
150mm	\$20.49	\$20.11	\$20.19	\$21.33	\$22.03	\$23.11	\$24.22	\$21.01	
175mm	\$22.36	\$21.98	\$22.06	\$23.19	\$23.89	\$24.98	\$26.09	\$22.88	
200mm	\$24.22	\$23.84	\$23.93	\$25.06	\$25.76	\$26.84	\$27.96	\$24.75	
225mm	\$26.82	\$26.29	\$26.41	\$27.99	\$28.97	\$30.49	\$32.04	\$27.55	
250mm	\$29.05	\$28.44	\$28.58	\$30.39	\$31.51	\$33.24	\$35.02	\$29.89	
300mm	\$33.51	\$32.76	\$32.92	\$35.18	\$36.59	\$38.76	\$40.98	\$34.56	
350mm	\$39.07	\$37.93	\$38.18	\$41.58	\$43.68	\$46.93	\$50.27	\$40.64	
400mm	\$44.62	\$43.11	\$43.44	\$47.97	\$50.78	\$55.11	\$59.56	\$46.72	
450mm	\$46.44	\$44.56	\$44.97	\$50.63	\$54.14	\$59.56	\$65.11	\$49.07	

## Sculptured drop to suit - .55mm Material - price per each

Diam	C/bond	Zinc	Gal	Ultra	Metallic	304 2b	316 2b	Matt	
90mm	\$24.22	\$23.84	\$23.93	\$25.06	\$25.76	\$26.84	\$27.96	\$24.75	
100mm	\$27.96	\$27.58	\$27.66	\$28.79	\$29.49	\$30.58	\$31.69	\$28.48	
125mm	\$30.92	\$30.31	\$30.44	\$32.25	\$33.38	\$35.11	\$36.89	\$31.75	
150mm	\$32.78	\$32.18	\$32.31	\$34.12	\$35.24	\$36.98	\$38.76	\$33.62	
225mm	\$37.24	\$36.49	\$36.66	\$38.92	\$40.32	\$42.49	\$44.71	\$38.29	
300mm	\$42.80	\$41.67	\$41.92	\$45.31	\$47.42	\$50.67	\$54.00	\$44.37	

## Eaves Gutter Library - First Edition

Almost 100 gutters included

Every Gutter has been supplied as a job previously

All Gutters use a Concealed Bracket

From Order to Site Delivery      24 to 48 hours

Bracket Material options      3mm Galvabond

4mm Duragal

5mm Duragal

6mm Duragal\*\* Subject to lead times

We have a drawn to scale version of every gutter if detailed drawings are required

Can't find a design to use - ask for a Custom Design

### CONTENTS

Gutters up to 400mm Girth	Page 2
Gutters from 401mm to 600mm Girth	Page 4
Gutters from 601mm to 800mm Girth	Page 15
Gutters from 801mm to 1000mm Girth	Page 20
Material Information	Page 23

**Request a Copy of Our Gutter Catalogue as Above**



---

# COMMERCIAL EAVES GUTTER BRACKETS

---

---

## CONCEALED BRACKET OPTION

---



# Up to 600mm Girth options include:

40mm x 3mm Galvabond

50mm x 4mm Duragal

40mm x 3mm 304 or 316 Stainless Steel

# Up to 1200mm Girth options include:

50mm x 4mm, 5mm or 6mm Duragal

50mm x 5mm 304 or 316 Stainless Steel

# Standard Lead Time is 2 Working Days

# Next Day Availability on request

---

## EXTERNAL BRACKET OPTION

---



# Up to 600mm Girth options include:

40mm x 3mm Galvabond

50mm x 4mm Duragal

40mm x 3mm 304 or 316 Stainless Steel

# Up to 1200mm Girth options include:

50mm x 4mm, 5mm or 6mm Duragal

50mm x 5mm 304 or 316 Stainless Steel

# Standard Lead Time is 7 Working Days for Powder Coated Brackets

# Expedited Availability on request

---

## Ask for our Commercial Eaves Gutter Catalogue -  
Over 100 Gutters Ranging from 400mm to 1200mm Girth.

All

Capable of using Concealed Brackets. All have been supplied to previous Jobs ##

---

# Duragal Flat Bar Bracket - Commercial Eaves Gutters

## Eaves Gutter Girth - Usual Bracket Thickness Used - Guide Only

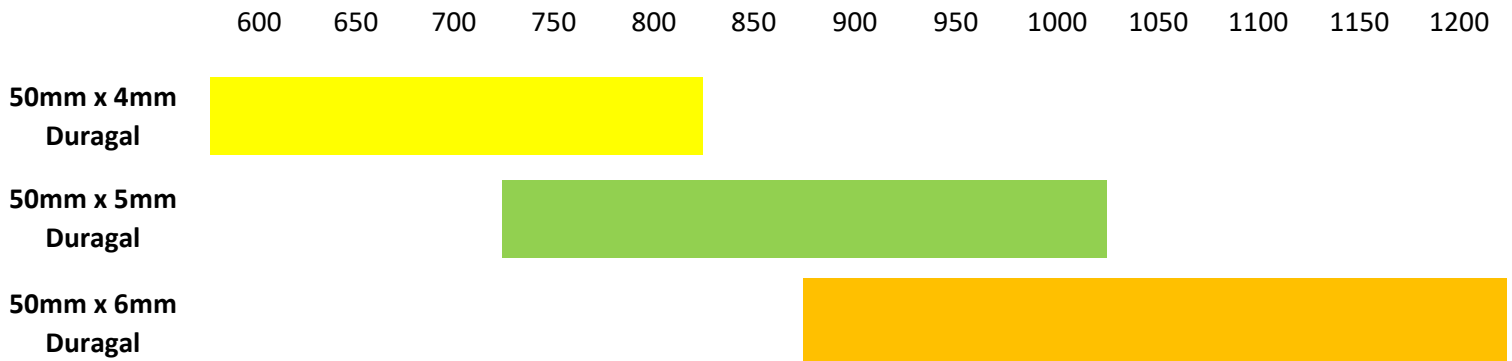

# Bracket thickness selected depends on many factors including Gutter Style, Capacity and Bracket Spacing

# Duragal Manufactured in Australia

## Lead Time to Site

	Concealed Bracket	External Powder Coated Bracket*
4mm Duragal	2 -3 Working days	1.5 weeks
5mm Duragal	2 -3 Working days	1.5 weeks
6mm Duragal	2 - 3 Working Days	1.5 weeks

**\* Coated by Dulux Approved Applicator and follows correct cleaning, chemical pre treatment, coating and curing process required for Duragal Flat Bar**

### How to Reduce Lead Time

# Pre Order Brackets which can be held at CSM, then Gutter and Accessories Lead Time is 2 Working Days

### Project Needs

# If you have upcoming Job needs - advise and we can hold stock or order additional

# COMMERCIAL HIGH FRONT SLOTTED EAVES GUTTERS

All have 85mm x 10mm slots @ 200mm centres

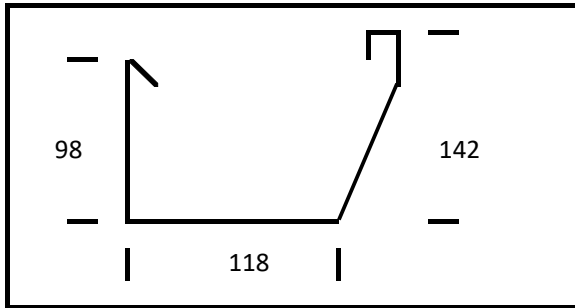

Concealed Bracket to Suit

40mm x 3mm Galvabond

Lead Time - 2 Working Days

**400 High Front - Capacity 10 500**

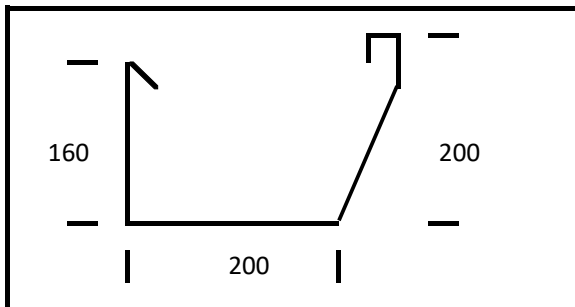

Concealed Bracket to Suit

40mm x 3mm Galvabond

Lead Time - 2 Working Days

**600 High Front - Capacity 27 500**

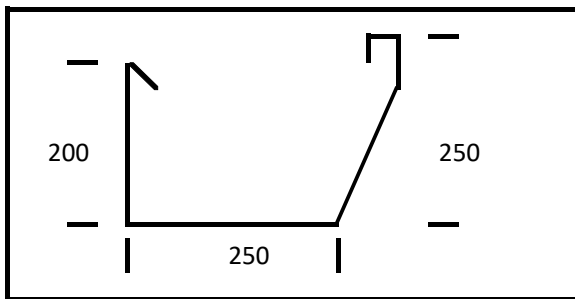

Concealed Bracket to Suit

50mm x 5mm Duragal

Lead Time - 2 Working Days

**800 High Front - Capacity 42 500**

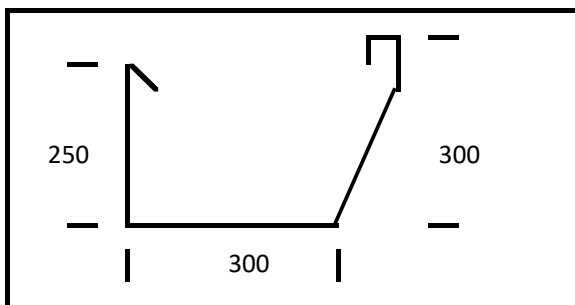

Concealed Bracket to Suit

50mm x 5mm Duragal

Lead Time - 2 Working Days

**1000 High Front - Capacity 65 000**

# Commercial High Front Slotted Eaves Gutter

Slotted @ 200mm centres - 85mm x 10mm

## .55mm Gutter - Price per lineal Metre

Gutter Size	C/bond	Zinc	Gal	Ultra	Metallic	304 2b	316 2b	Matt	
400mm	\$23.50	\$20.38	\$21.91	\$29.82	\$34.74	N/A	N/A	\$27.64	
600mm	\$28.97	\$25.19	\$27.26	\$39.13	\$46.51	N/A	N/A	\$35.85	
800mm	\$37.53	\$31.98	\$33.67	\$60.06	\$72.97	N/A	N/A	\$54.33	
1000mm	\$44.51	\$37.00	\$43.30	\$67.04	\$81.80	N/A	N/A	\$60.49	
1200mm	\$47.66	\$40.10	\$43.30	\$67.04	\$81.80	N/A	N/A	\$60.49	

## Concealed Bracket to Suit - Price per each

Gutter Size	40mm x 3mm Flat Bar			50mm x 4mm Flat Bar	50mm x 5mm Flat Bar			50mm x 6mm
	Galvabond	304 SS	316 SS	Duragal	Duragal	304 SS	316 SS	Duragal
400mm	\$10.41							
600mm	\$11.70	\$29.07	\$33.87	\$16.04				
800mm				\$19.55	\$22.18	\$70.60	\$81.40	
1000mm					\$25.94			\$31.00
1200mm								\$37.20

## .55mm Stop End - Price per each

Gutter Size	C/bond	Zinc	Gal	Ultra	Metallic	304 2b	316 2b	Matt	
400mm	\$22.31	\$21.56	\$21.72	\$23.98	\$25.39	\$27.56	\$29.78	\$23.36	
600mm	\$27.87	\$26.73	\$26.98	\$30.38	\$32.48	\$35.73	\$39.07	\$29.44	
800mm	\$27.87	\$26.73	\$26.98	\$30.38	\$32.48	\$35.73	\$39.07	\$29.44	
1000mm	\$35.24	\$33.36	\$33.77	\$39.43	\$42.94	\$48.36	\$53.91	\$37.87	
1200mm	\$35.24	\$33.36	\$33.77	\$39.43	\$42.94	\$48.36	\$53.91	\$37.87	

## Powder Coated External Bracket to Suit - Price per each

Gutter Size	40mm x 5mm Aluminium	40mm x 3mm Galvabond	50mm x 4mm Duragal	50mm x 5mm Duragal	50mm x 6mm
					Duragal
400mm	\$22.07	\$21.34			
600mm	\$24.87	\$22.63	\$28.34		
800mm			\$33.05	\$36.05	
1000mm				\$40.61	\$45.67
1200mm					\$56.40

**Brackets - Small Order Powder Coating Surcharge if Under 7 Brackets**

**\$60.00**

## Stainless External Bracket to Suit - Price per each

Gutter Size	40mm x 3mm 304	40mm x 3mm 316	50mm x 5mm 304	50mm x 5mm 316
400mm	\$27.33	\$28.27		
600mm	\$36.33	\$38.67	\$53.20	\$59.73
800mm			\$67.20	\$76.53
1000mm				

# COMMERCIAL EAVES GUTTER - Unslotted Low Front

Many Unslotted Versions Available - See separate gutter catalogue - almost 100 gutters

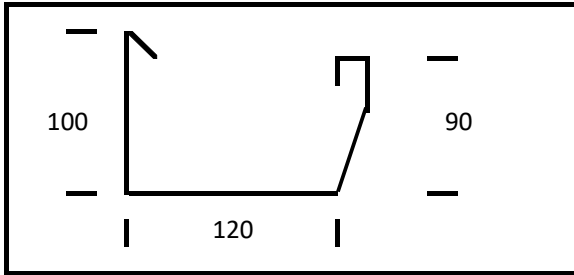

Concealed Bracket to Suit

40mm x 3mm Galvabond

Lead Time - 2 Working Days

**400 Low Front - Capacity 12 000**

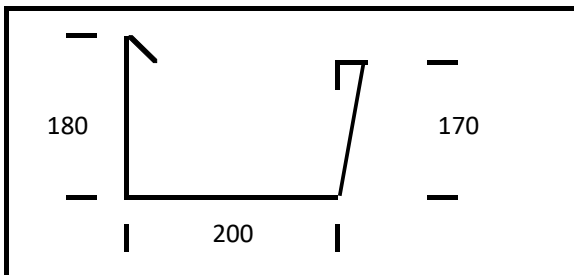

Concealed Bracket to Suit

40mm x 3mm Galvabond

Lead Time - 2 Working Days

**600 Low Front - Capacity 35 000**

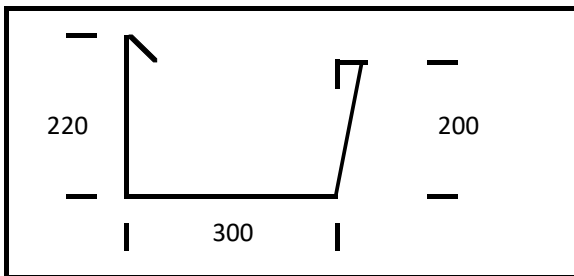

Concealed Bracket to Suit

50mm x 5mm Duragal

Lead Time - 2 Working Days

**800 Low Front - Capacity 60 000**

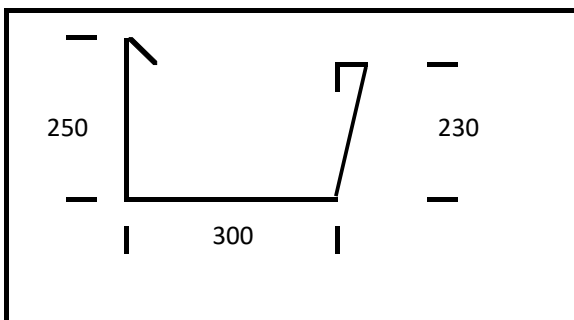

Concealed Bracket to Suit

50mm x 5mm Duragal

Lead Time - 2 Working Days

**1000 Low Front - Capacity 70 000**

# OG Style Gutters

# Smooth Rolled Up to 6 metres length

# Slotted if Requested - 85mm x 10mm slot @ 500mm centres

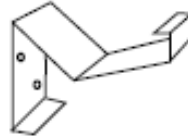
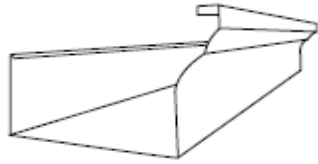

600mm Gutter	450mm Gutter

**## We Recommend a Maximum length of 4 Metres for OG Gutter, 6 metre length can be achieved but there will be a Visible Mark on the face from the finishing Process**

## Gutter Capacity

Gutter	Effective Cross-Sectional Area (mm <sup>2</sup> )	
	Slotted	Unslotted
450	12000	16500
600	22550	28700

## Concealed Brackets to Suit

Gutter	Bracket Material
450	40mm x 3mm Galvabond
600	40mm x 3mm Galvabond

**Standard Lead Time is 3 Working Days**

# OG Gutters

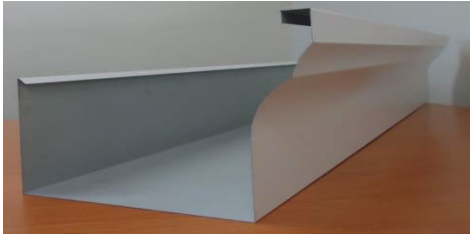

# Up to 6 metre length

# Can be Slotted - 85mm x 10mm  
@ 500mm centres

## We Recommend a Maximum length of 4 Metres for OG Gutter, 6 metre length can be achieved but there will be a Visible Mark on the face from the finishing Process

## .55mm Material - Price per lineal Metre - Unslotted

Girth	C/bond	Zinc	Gal	Ultra	Metallic	304 2b	316 2b	Matt	
450mm	\$31.33	\$29.38	\$30.21	\$41.52	\$48.54	\$59.38	\$70.49	\$38.40	
600mm	\$35.02	\$31.24	\$32.08	\$43.38	\$50.41	\$61.24	\$72.36	\$40.27	
Extra for Slotting	\$4.00	\$4.00	\$4.00	\$4.00	\$4.00	N/A	N/A	\$4.00	



## Concealed Brackets

40mm x 3mm Galvabond  
40mm x 3mm 304 Stainless  
40mm x 3mm 316 Stainless

\$11.70	each
\$29.07	each
\$33.87	each



## Stop Ends

## .55mm Material - Price per Stop End

	C/bond	Zinc	Gal	Ultra	Metallic	304 2b	316 2b	Matt	
All Sizes	\$27.87	\$26.73	\$26.98	\$30.38	\$32.48	\$35.73	\$39.07	\$29.44	



## .55mm Material - Price per Corner (300mm x 300mm) - Unslotted

Girth	C/bond	Zinc	Gal	Ultra	Metallic	304 2b	316 2b	Matt	
450mm	\$127.67	\$123.76	\$125.42	\$148.03	\$162.09	\$183.76	\$205.98	\$141.80	
600mm	\$140.04	\$132.49	\$134.16	\$156.77	\$170.82	\$192.49	\$214.71	\$150.53	

# Quad Gutters



# Up to 6 metre length  
# Unslotted

# Flat bar external bracket

# Loose Stop End

## .55mm Material - Price per lineal Metre

Gutter	C/bond	Zinc	Gal	Ultra	Metallic	304 2b	316 2b	Matt	
125mm	\$19.38	\$18.42	\$18.84	\$24.49	\$28.01	\$33.42	\$38.98	\$22.93	
150mm	\$23.23	\$21.67	\$22.22	\$29.68	\$34.32	\$41.47	\$48.80	\$27.62	
175mm	\$24.16	\$22.60	\$23.15	\$30.61	\$35.25	\$42.40	\$49.73	\$28.55	
200mm	\$26.96	\$24.47	\$25.02	\$32.48	\$37.12	\$44.27	\$51.60	\$30.42	
250mm	\$31.33	\$29.38	\$30.21	\$41.52	\$48.54	\$59.38	\$70.49	\$38.40	

## Flat Bar External Bracket - price per each

	3mm Gal + P/Coat		Plain	3mm Gal + P/C			3mm Stainless		3mm Gal + P/Coat	
Gutter	C/bond	Zinc	Gal	Ultra	Metallic	304 2b	316 2b	Matt		
125mm	\$25.63	\$27.13	\$15.70	\$25.63	\$27.63	\$40.33	\$42.67	\$25.63		
150mm	\$26.63	\$28.13	\$16.70	\$26.63	\$28.63	\$41.33	\$43.67	\$26.63		
175mm	\$27.63	\$29.13	\$17.70	\$27.63	\$29.63	\$42.33	\$44.67	\$27.63		
200mm	\$28.63	\$30.13	\$18.70	\$28.63	\$30.63	\$43.33	\$45.67	\$28.63		
250mm	\$29.63	\$31.13	\$19.70	\$29.63	\$31.63	\$44.33	\$46.67	\$29.63		

Bracket Lead Time

7 Working Days

## Stop End - price per each

Gutter	C/bond	Zinc	Gal	Ultra	Metallic	304 2b	316 2b	Matt	
125mm	\$24.22	\$23.84	\$23.93	\$25.06	\$25.76	\$26.84	\$27.96	\$24.75	
150mm	\$26.82	\$26.29	\$26.41	\$27.99	\$28.97	\$30.49	\$32.04	\$27.55	
175mm	\$29.05	\$28.44	\$28.58	\$30.39	\$31.51	\$33.24	\$35.02	\$29.89	
200mm	\$33.51	\$32.76	\$32.92	\$35.18	\$36.59	\$38.76	\$40.98	\$34.56	
250mm	\$39.07	\$37.93	\$38.18	\$41.58	\$43.68	\$46.93	\$50.27	\$40.64	

## Corner - price per each

Gutter	C/bond	Zinc	Gal	Ultra	Metallic	304 2b	316 2b	Matt	
125mm	\$83.76	\$81.84	\$82.68	\$93.98	\$101.01	\$111.84	\$122.96	\$90.87	
150mm	\$91.45	\$88.33	\$89.43	\$104.36	\$113.63	\$127.93	\$142.60	\$100.24	
175mm	\$93.32	\$90.20	\$91.30	\$106.22	\$115.50	\$129.80	\$144.47	\$102.11	
200mm	\$103.92	\$98.93	\$100.03	\$114.96	\$124.23	\$138.53	\$153.20	\$110.84	
250mm	\$117.67	\$113.76	\$115.42	\$138.03	\$152.09	\$173.76	\$195.98	\$131.80	



---

# Fabricated Items Cover Page

---

## Next Day on Request - Pending Time of Order

---



Width

### Gal Box Gutter Brackets

Fabricated to Size

\* 1.6mm Gal Channel for Base

\* 1mm Gal strap

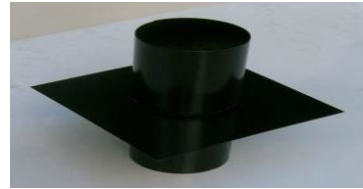
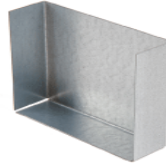
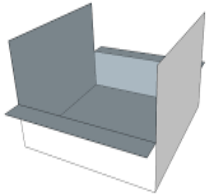
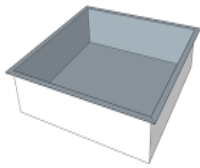

---

## Standard 2 Working Day Lead Time

---

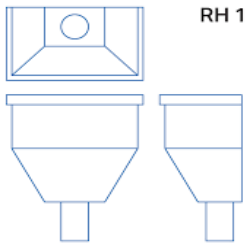

RH 1

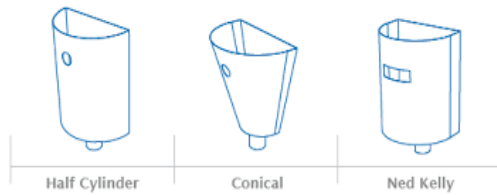

Half Cylinder

Conical

Ned Kelly

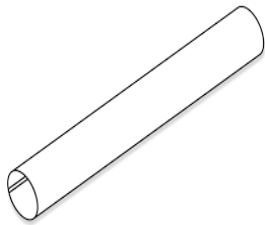
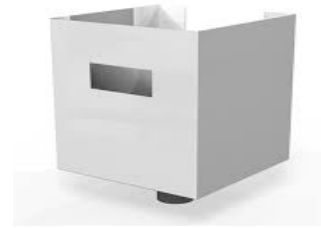

Round Downpipe to 6 metres

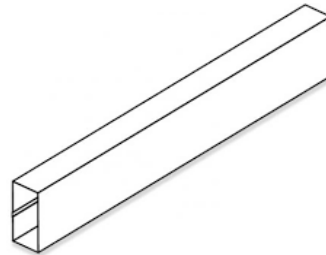

Rectangle Downpipe to 4 metres

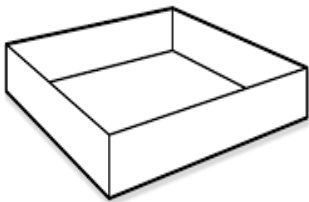

---

## Longer Lead Times

---

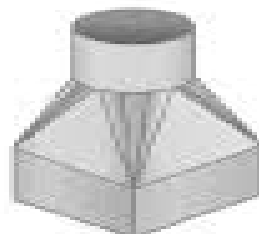

## Light Gauge Fabricated Items - General Lead Time Guide

Item	Next Day Availability	48 Hour Availibility	Other (Working Days)
Box Gutter Brackets	On Request	✓	
Stop Ends	On Request	✓	
Overflows	On Request	✓	
Chinaman Hats	X	✓	
Standard Sump	On Request	✓	
Tapered Bottom Sump	X	✓	
Sump with fitted drop	X	✓	
Hich Capacity Sump Units	X	X	3 days
Rainhead - Rectangle	On Request	✓	
Rainhead - Conical	On Request	✓	
Rainhead - Flat Bottom	On Request	✓	
Rainhead - Detailed design	X	X	3 -5 days
Round Downpipe - Straight	On Request	✓	
Round Downpipe Offset	X	✓	
Round Downpipe Elbow	X	✓	
T Bracket & Clip	On Request	✓	
Clip Only	On Request	✓	
Fabricated Drop	On Request	✓	
Rectangle Downpipe - Straight	On Request	✓	
Rectangle Downpipe Offset	X	✓	
Rectangle Downpipe Elbow	X	✓	
Rectangle Downpipe Clip	On Request	✓	
Rectangle Fabricated Drop	On Request	✓	
Fixed Metal Louvre	X	X	3 - 5 days
Ridge Vent	X	X	2 weeks
Window Hood	X	X	3 -5 days
Curves	X	On Request	3 days
Safe Trays	On Request	✓	
Spitters	On Request	✓	
Reducers / Transitions	X	✓	
Folded Downpipe Protectors	X	X	3 - 5 days
Circular Downpipe Protectors			
Hot Dip Galvanised	X	X	3 - 6 weeks
Pre Galvanised	X	X	1 - 2 week
Lockseam Flashings	X	✓	
<b>## Next Day Availability - Occasionally Possible if Order Placed prior to 10am ##</b>			

# Working Days lead Time Guide

# I have been given a Lead Time based on Working days but when will it be Ready?

# The count starts on the day after order is placed

# Example - Order Placed on Monday, **Day Number 1 is Tuesday**

## Day Order Placed

**Monday                  Tuesday                  Wednesday                  Thursday                  Friday**

## Order Due for Delivery

### Working Days

<b>1 - Next Day</b>	Tuesday	Wednesday	Thursday	Friday	Monday
<b>2</b>	Wednesday	Thursday	Friday	Monday	Tuesday
<b>3</b>	Thursday	Friday	Monday	Tuesday	Wednesday
<b>4</b>	Friday	Monday	Tuesday	Wednesday	Thursday
<b>5 - 1 week</b>	Monday	Tuesday	Wednesday	Thursday	Friday
<b>6</b>	Tuesday	Wednesday	Thursday	Friday	Monday
<b>7</b>	Wednesday	Thursday	Friday	Monday	Tuesday
<b>8</b>	Thursday	Friday	Monday	Tuesday	Wednesday
<b>9</b>	Friday	Monday	Tuesday	Wednesday	Thursday
<b>10 - 2 weeks</b>	Monday	Tuesday	Wednesday	Thursday	Friday

### Not Counted in Working days Lead Time

- Public Holidays
- Saturday
- Sunday
- Christmas Shutdown Period

# Box Gutters & Accessories



Width

\* 1.6mm Gal Channel for Base

\* 1mm Gal strap

## Gal Box Gutter Brackets - Fabricated to Size

Up to 400mm wide  
 401mm to 600mm wide  
 601mm to 800mm wide  
 801mm to 1000mm wide  
 1001mm to 1200mm wide  
 1201mm to 1500mm wide

\$10.71	each
\$12.28	each
\$14.76	each
\$17.12	each
\$22.09	each
\$29.12	each



## Gutter Board - 580mm cover x 6500mm Long

\* Kept in stock

Per Length

\$118.00	each
----------	------

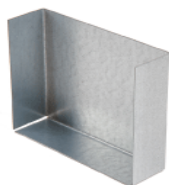

## Stop Ends - Supplied Loose

### .55mm Stop End - Price per each

Gutter Girth	C/bond	Zinc	Gal	Ultra	Metallic	304 2b	316 2b	Matt
400mm	\$22.31	\$21.56	\$21.72	\$23.98	\$25.39	\$27.56	\$29.78	\$23.36
600mm	\$27.87	\$26.73	\$26.98	\$30.38	\$32.48	\$35.73	\$39.07	\$29.44
800mm	\$27.87	\$26.73	\$26.98	\$30.38	\$32.48	\$35.73	\$39.07	\$29.44
1000mm	\$35.24	\$33.36	\$33.77	\$39.43	\$42.94	\$48.36	\$53.91	\$37.87
1200mm	\$35.24	\$33.36	\$33.77	\$39.43	\$42.94	\$48.36	\$53.91	\$37.87



# Spitter

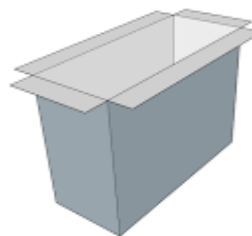

### Fabricated Spitter - up to 400mm long

Size	C/bond	Zinc	Gal	Ultra	Metallic	304 2b	316 2b	Matt
75mm x 75mm	\$44.62	\$43.11	\$43.44	\$47.97	\$50.78	\$55.11	\$59.56	\$46.72
100mm x 75mm	\$44.62	\$43.11	\$43.44	\$47.97	\$50.78	\$55.11	\$59.56	\$46.72
100mm x 50mm	\$44.62	\$43.11	\$43.44	\$47.97	\$50.78	\$55.11	\$59.56	\$46.72
100mm x 100mm	\$44.62	\$43.11	\$43.44	\$47.97	\$50.78	\$55.11	\$59.56	\$46.72
100mm x 150mm	\$46.44	\$44.56	\$44.97	\$50.63	\$54.14	\$59.56	\$65.11	\$49.07
150mm x 150mm	\$46.44	\$44.56	\$44.97	\$50.63	\$54.14	\$59.56	\$65.11	\$49.07
200mm x 200mm	\$57.47	\$54.07	\$54.82	\$64.99	\$71.32	\$81.07	\$91.07	\$62.19
250mm x 250mm	\$59.29	\$55.51	\$56.34	\$67.65	\$74.68	\$85.51	\$96.62	\$64.53
300mm x 300mm	\$68.49	\$63.58	\$64.66	\$79.36	\$88.49	\$102.58	\$117.02	\$75.31

# Box Gutters & Accessories

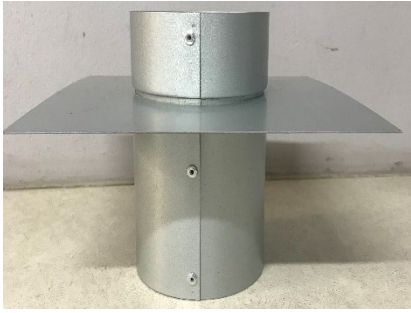

## \* Round Overflows

\* Allowed up to 500mm Overall Height

### .55mm Overflow - Price per each

Diam	C/bond	Zinc	Gal	Ultra	Metallic	304 2b	316 2b	Matt	
75mm	\$80.13	\$79.00	\$79.25	\$82.64	\$84.75	\$88.00	\$91.33	\$81.71	
90mm	\$61.47	\$60.33	\$60.58	\$63.98	\$66.08	\$69.33	\$72.67	\$63.04	
100mm	\$63.29	\$61.78	\$62.11	\$66.63	\$69.44	\$73.78	\$78.22	\$65.39	
125mm	\$73.53	\$71.83	\$72.21	\$77.30	\$80.46	\$85.33	\$90.33	\$75.89	
150mm	\$83.78	\$81.89	\$82.31	\$87.96	\$91.47	\$96.89	\$102.44	\$86.40	
225mm	\$109.73	\$106.33	\$107.08	\$117.26	\$123.58	\$133.33	\$143.33	\$114.45	
300mm	\$137.51	\$132.22	\$133.39	\$149.22	\$159.06	\$174.22	\$189.78	\$144.85	

## \* Round Overflows

\* 501mm to 800mm Overall Height

### .55mm Overflow - Price per each

Diam	C/bond	Zinc	Gal	Ultra	Metallic	304 2b	316 2b	Matt	
75mm	\$100.17	\$98.75	\$99.06	\$103.30	\$105.94	\$110.00	\$114.17	\$102.13	
90mm	\$76.83	\$75.42	\$75.73	\$79.97	\$82.60	\$86.67	\$90.83	\$78.80	
100mm	\$79.11	\$77.22	\$77.64	\$83.29	\$86.81	\$92.22	\$97.78	\$81.73	
125mm	\$91.92	\$89.79	\$90.26	\$96.62	\$100.57	\$106.67	\$112.92	\$94.87	
150mm	\$104.72	\$102.36	\$102.88	\$109.95	\$114.34	\$121.11	\$128.06	\$108.00	
225mm	\$137.17	\$132.92	\$133.85	\$146.57	\$154.48	\$166.67	\$179.17	\$143.07	
300mm	\$171.89	\$165.28	\$166.74	\$186.52	\$198.82	\$217.78	\$237.22	\$181.07	



## \* Chinaman Hats

\* 3 legs riveted / spot welded

### .55mm Chinaman Hat - Price per each

Diam	C/bond	Zinc	Gal	Ultra	Metallic	304 2b	316 2b	Matt	
75mm	\$80.13	\$79.00	\$79.25	\$82.64	\$84.75	\$88.00	\$91.33	\$81.71	
90mm	\$61.47	\$60.33	\$60.58	\$63.98	\$66.08	\$69.33	\$72.67	\$63.04	
100mm	\$63.29	\$61.78	\$62.11	\$66.63	\$69.44	\$73.78	\$78.22	\$65.39	
125mm	\$73.53	\$71.83	\$72.21	\$77.30	\$80.46	\$85.33	\$90.33	\$75.89	
150mm	\$83.78	\$81.89	\$82.31	\$87.96	\$91.47	\$96.89	\$102.44	\$86.40	
225mm	\$109.73	\$106.33	\$107.08	\$117.26	\$123.58	\$133.33	\$143.33	\$114.45	
300mm	\$137.51	\$132.22	\$133.39	\$149.22	\$159.06	\$174.22	\$189.78	\$144.85	

# Sumps

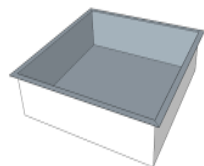

\* Standard Flat Bottom Style

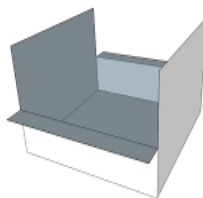

\* Inline Style

\* Stop End Style

## .55mm Sump - Price per each

Size	C/bond	Zinc	Gal	Ultra	Metallic	304 2b	316 2b	Matt	
300mm Square	\$89.24	\$86.22	\$86.89	\$95.93	\$101.56	\$110.22	\$119.11	\$93.44	
400mm Square	\$92.89	\$89.11	\$89.94	\$101.25	\$108.28	\$119.11	\$130.22	\$98.13	
500mm Square	\$96.53	\$92.00	\$93.00	\$106.57	\$115.00	\$128.00	\$141.33	\$102.83	
600mm Square	\$102.00	\$96.33	\$97.58	\$114.54	\$125.08	\$141.33	\$158.00	\$109.87	
700mm Square	\$118.62	\$111.44	\$113.03	\$134.51	\$147.86	\$168.44	\$189.56	\$128.59	
800mm Square	\$133.42	\$125.11	\$126.94	\$151.82	\$167.28	\$191.11	\$215.56	\$144.96	
900mm Square	\$140.71	\$130.89	\$133.06	\$162.45	\$180.72	\$208.89	\$237.78	\$154.35	
1000mm Square	\$170.31	\$158.22	\$160.89	\$197.07	\$219.56	\$254.22	\$289.78	\$187.09	

### Price Notes

- # When unequal sides - use the biggest side
- # Prices above cover up to 150mm Deep Sumps
- # If 151mm to 250mm Deep - go to next size up
- # If 251mm to 350mm Deep - go 2 sizes up



\* Tapered Bottom Sumps

## .55mm Material - Price per each

Size	C/bond	Zinc	Gal	Ultra	Metallic	304 2b	316 2b	Matt	
300mm Square	\$133.87	\$129.33	\$130.33	\$143.90	\$152.33	\$165.33	\$178.67	\$140.16	
400mm Square	\$139.33	\$133.67	\$134.92	\$151.88	\$162.42	\$178.67	\$195.33	\$147.20	
500mm Square	\$144.80	\$138.00	\$139.50	\$159.85	\$172.50	\$192.00	\$212.00	\$154.24	
600mm Square	\$153.00	\$144.50	\$146.38	\$171.81	\$187.63	\$212.00	\$237.00	\$164.80	
700mm Square	\$177.93	\$167.17	\$169.54	\$201.76	\$221.79	\$252.67	\$284.33	\$192.88	
800mm Square	\$200.13	\$187.67	\$190.42	\$227.73	\$250.92	\$286.67	\$323.33	\$217.44	
900mm Square	\$211.07	\$196.33	\$199.58	\$243.68	\$271.08	\$313.33	\$356.67	\$231.52	
1000mm Square	\$255.47	\$237.33	\$241.33	\$295.60	\$329.33	\$381.33	\$434.67	\$280.64	

### Price Notes

- # When unequal sides - use the biggest side
- # Prices above cover up to 150mm Deep Sumps
- # If 151mm to 250mm Deep - go to next size up
- # If 251mm to 350mm Deep - go 2 sizes up

## Option for Fitted Drop into Any Sump as Extra

	C/bond	Zinc	Gal	Ultra	Metallic	304 2b	316 2b	Matt	
100 or 150mm	\$59.64	\$58.89	\$59.06	\$61.32	\$62.72	\$64.89	\$67.11	\$60.69	
225mm	\$69.64	\$68.89	\$69.06	\$71.32	\$72.72	\$74.89	\$77.11	\$70.69	

# High Capacity Sump Units

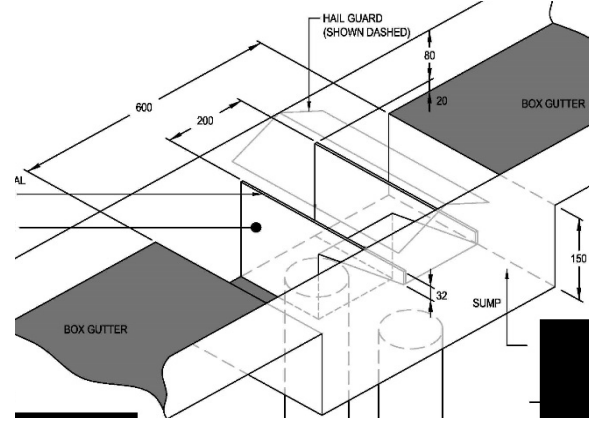
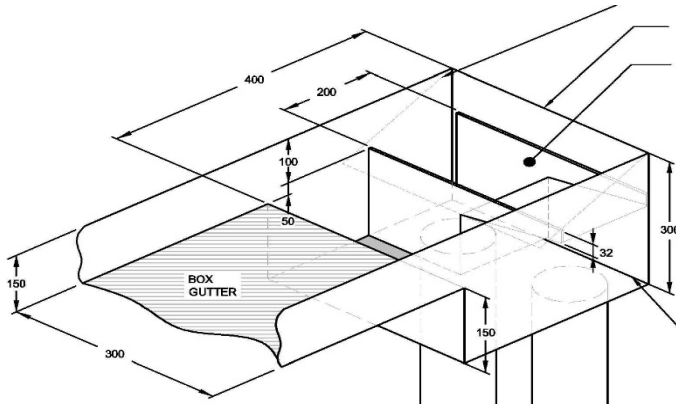

## Included Per Unit - Fitted

# Sump                      # Weir                      # 2 x Drops

### Price Per Unit With Up to 150mm diam drop - 2 off

Sump Size	C/bond	Zinc	Gal	Ultra	Metallic	304 2b	316 2b	Matt
400mm square	\$301.42	\$294.62	\$296.12	\$316.47	\$329.12	\$348.62	\$368.62	\$310.86
600mm square	\$314.18	\$304.73	\$306.82	\$335.08	\$352.65	\$379.73	\$407.51	\$327.29
800mm square	\$349.24	\$336.40	\$339.23	\$377.67	\$401.57	\$438.40	\$476.18	\$367.08
1000mm square	\$391.60	\$373.84	\$377.76	\$430.90	\$463.93	\$514.84	\$567.07	\$416.25

### Price Per Unit With 2 x 225mm or 300mm diam drop

Sump Size	C/bond	Zinc	Gal	Ultra	Metallic	304 2b	316 2b	Matt
600mm square	\$334.18	\$323.22	\$325.64	\$358.43	\$378.81	\$410.22	\$442.44	\$349.39
800mm square	\$369.24	\$356.40	\$359.23	\$397.67	\$421.57	\$458.40	\$496.18	\$387.08
1000mm square	\$411.60	\$393.84	\$397.76	\$450.90	\$483.93	\$534.84	\$587.07	\$436.25

### Option for Weir Supplied Loose

Sump Size	C/bond	Zinc	Gal	Ultra	Metallic	304 2b	316 2b	Matt
400mm square	\$89.24	\$86.22	\$86.89	\$95.93	\$101.56	\$110.22	\$119.11	\$93.44
600mm square	\$92.89	\$89.11	\$89.94	\$101.25	\$108.28	\$119.11	\$130.22	\$98.13
800mm square	\$96.53	\$92.00	\$93.00	\$106.57	\$115.00	\$128.00	\$141.33	\$102.83
1000mm square	\$102.00	\$96.33	\$97.58	\$114.54	\$125.08	\$141.33	\$158.00	\$109.87

# All Other Loose components refer sump and drop pricing

# Rainheads

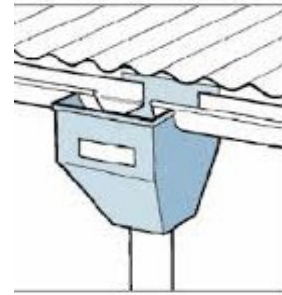
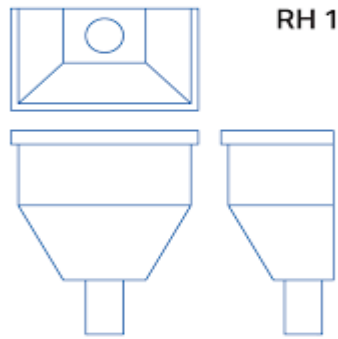

## Rectangular Style Rainheads

.55mm Material - Price per Each

Width	C/bond	Zinc	Gal	Ultra	Metallic	304 2b	316 2b	Matt
300mm	\$268.18	\$262.89	\$264.06	\$279.88	\$289.72	\$304.89	\$320.44	\$275.52
400mm	\$275.47	\$268.67	\$270.17	\$290.52	\$303.17	\$322.67	\$342.67	\$284.91
500mm	\$305.07	\$296.00	\$298.00	\$325.13	\$342.00	\$368.00	\$394.67	\$317.65
600mm	\$312.36	\$301.78	\$304.11	\$335.77	\$355.44	\$385.78	\$416.89	\$327.04
750mm	\$341.96	\$329.11	\$331.94	\$370.38	\$394.28	\$431.11	\$468.89	\$359.79
900mm	\$371.56	\$356.44	\$359.78	\$405.00	\$433.11	\$476.44	\$520.89	\$392.53
1200mm	\$464.44	\$445.56	\$449.72	\$506.25	\$541.39	\$595.56	\$651.11	\$490.67

Price Notes

\* Fitted Drop is included in Price

## Conical Style Rainheads

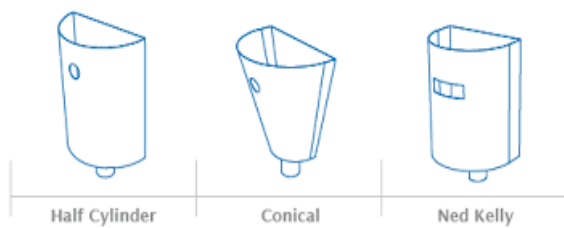

.55mm Material - Price per Each

Width	C/bond	Zinc	Gal	Ultra	Metallic	304 2b	316 2b	Matt
300mm	\$268.18	\$262.89	\$264.06	\$279.88	\$289.72	\$304.89	\$320.44	\$275.52
400mm	\$275.47	\$268.67	\$270.17	\$290.52	\$303.17	\$322.67	\$342.67	\$284.91
500mm	\$305.07	\$296.00	\$298.00	\$325.13	\$342.00	\$368.00	\$394.67	\$317.65
600mm	\$312.36	\$301.78	\$304.11	\$335.77	\$355.44	\$385.78	\$416.89	\$327.04
750mm	\$341.96	\$329.11	\$331.94	\$370.38	\$394.28	\$431.11	\$468.89	\$359.79
900mm	\$371.56	\$356.44	\$359.78	\$405.00	\$433.11	\$476.44	\$520.89	\$392.53
1200mm	\$464.44	\$445.56	\$449.72	\$506.25	\$541.39	\$595.56	\$651.11	\$490.67

Price Notes

\* Fitted Drop is included in Price

### Option for Overflow Hole or Fitted Overflow - Extra

	C/bond	Zinc	Gal	Ultra	Metallic	304 2b	316 2b	Matt
Hole Cut Only	\$29.87	\$29.87	\$29.87	\$29.87	\$29.87	\$29.87	\$29.87	\$29.87
Fitted Overflow	\$59.64	\$58.89	\$59.06	\$61.32	\$62.72	\$64.89	\$67.11	\$60.69



# Rainheads

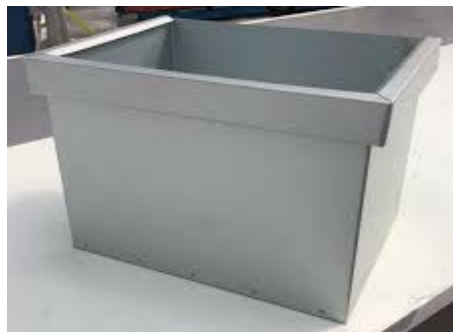

## Flat Bottom Style Rainheads

### .55mm Material - Price per Each

Width	C/bond	Zinc	Gal	Ultra	Metallic	304 2b	316 2b	Matt	
300mm	\$238.18	\$232.89	\$234.06	\$249.88	\$259.72	\$274.89	\$290.44	\$245.52	
400mm	\$245.47	\$238.67	\$240.17	\$260.52	\$273.17	\$292.67	\$312.67	\$254.91	
500mm	\$275.07	\$266.00	\$268.00	\$295.13	\$312.00	\$338.00	\$364.67	\$287.65	
600mm	\$282.36	\$271.78	\$274.11	\$305.77	\$325.44	\$355.78	\$386.89	\$297.04	
750mm	\$311.96	\$299.11	\$301.94	\$340.38	\$364.28	\$401.11	\$438.89	\$329.79	
900mm	\$341.56	\$326.44	\$329.78	\$375.00	\$403.11	\$446.44	\$490.89	\$362.53	
1200mm	\$426.94	\$408.06	\$412.22	\$468.75	\$503.89	\$558.06	\$613.61	\$453.17	

Price Notes

\* Fitted Drop is included in Price

### Option for Overflow Hole or Fitted Overflow - Extra

	C/bond	Zinc	Gal	Ultra	Metallic	304 2b	316 2b	Matt	
Hole Cut Only	\$29.87	\$29.87	\$29.87	\$29.87	\$29.87	\$29.87	\$29.87	\$29.87	
Fitted Overflow	\$59.64	\$58.89	\$59.06	\$61.32	\$62.72	\$64.89	\$67.11	\$60.69	

## Leaf Eater Style Rainheads



# Gal Mesh On top

# Mozzie Mesh inside

### .55mm Material - Price per Each

Suit Drop size	C/bond	Zinc	Gal	Ultra	Metallic	304 2b	316 2b	Matt	
100mm	\$312.36	\$301.78	\$304.11	\$335.77	\$355.44	\$385.78	\$416.89	\$327.04	
150mm	\$341.96	\$329.11	\$331.94	\$370.38	\$394.28	\$431.11	\$468.89	\$359.79	
225mm	\$371.56	\$356.44	\$359.78	\$405.00	\$433.11	\$476.44	\$520.89	\$392.53	
300mm	\$464.44	\$445.56	\$449.72	\$506.25	\$541.39	\$595.56	\$651.11	\$490.67	

Price Notes

\* Fitted Drop is included in Price

# Round Downpipe

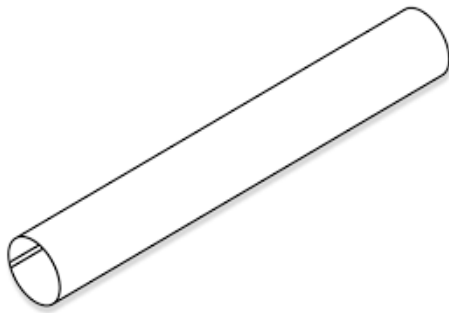

# Up to 6 metre Lengths

# 75mm diam to 300mm diam

# Riveted Bends to make offset

# Tapered downpipe

# T brackets & Clips Available

# Downpipe is charged per metre with 1 metre minimum charge

# Standard Pipe lead Time is 2 Working Days, offsets longer

## .55mm Downpipe - Price per lineal Metre

Diam	Max	C/bond	Zinc	Gal	Ultra	Metallic	304 2b	316 2b	Matt
75mm	2.4 metre	\$29.60	\$27.33	\$29.70	\$36.48	\$42.57	\$49.07	\$55.73	\$34.61
90mm	Up to 6 metre length	\$26.96	\$24.47	\$26.88	\$34.35	\$38.98	\$46.13	\$53.47	\$32.29
100mm		\$27.69	\$25.04	\$27.49	\$35.41	\$40.33	\$47.91	\$55.69	\$33.23
125mm		\$35.02	\$31.24	\$33.94	\$45.25	\$52.28	\$63.11	\$74.22	\$42.13
150mm		\$35.02	\$31.24	\$33.94	\$45.25	\$52.28	\$63.11	\$74.22	\$40.27
225mm	2.4 metre	\$48.80	\$43.13	\$45.32	\$63.21	\$73.75	\$90.00	\$106.67	\$58.53
300mm		\$60.71	\$53.16	\$56.69	\$79.30	\$93.36	\$115.02	\$137.24	\$73.07

## .55mm Material - Price Per Each Riveted Bend - Labour Only

Diam	75mm	90mm	100mm	125mm	150mm	225mm	300mm
C/bond, Zinc Gal	\$56.00	\$56.00	\$56.00	\$63.47	\$63.47	\$74.67	\$80.67
Stainless	\$63.47	\$63.47	\$63.47	\$74.67	\$74.67	\$79.67	\$85.67

## Offset - Fabricated to Size



### Pricing Notes

\* Allow for the amount of pipe required at per metre rates from top of page

\* Add Price for 2 x Riveted Bends as per below (or as many bends as required)

# Round Downpipe

## Adjustable Offset - .55mm Material - Price per unit

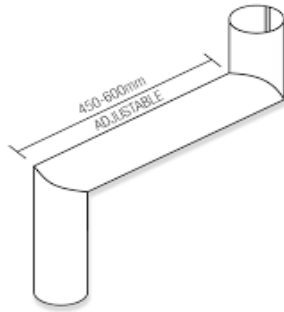

Diam	C/bond	Zinc	Gal	Ultra	Metallic	304 2b	316 2b	Matt
75mm	\$171.20	\$166.67	\$171.40	\$184.97	\$212.07	\$225.07	\$238.40	\$181.23
90mm	\$165.92	\$160.93	\$165.77	\$180.69	\$204.90	\$219.20	\$233.87	\$176.58
100mm	\$167.38	\$162.09	\$166.99	\$182.82	\$207.59	\$222.76	\$238.31	\$178.45
125mm	\$196.98	\$189.42	\$194.82	\$217.43	\$253.89	\$275.56	\$297.78	\$211.20
150mm	\$196.98	\$189.42	\$194.82	\$217.43	\$253.89	\$275.56	\$297.78	\$207.47
225mm	\$246.93	\$235.60	\$239.97	\$275.75	\$306.83	\$339.33	\$372.67	\$266.40
300mm	\$282.76	\$267.64	\$274.71	\$319.93	\$358.04	\$401.38	\$445.82	\$307.47

## Riveted Elbow - 300mm x 300mm



## .55mm Material - Price Per Elbow

Diam	C/bond	Zinc	Gal	Ultra	Metallic	304 2b	316 2b	Matt
75mm	\$85.60	\$83.33	\$85.70	\$92.48	\$106.03	\$112.53	\$119.20	\$90.61
90mm	\$82.96	\$80.47	\$82.88	\$90.35	\$102.45	\$109.60	\$116.93	\$88.29
100mm	\$83.69	\$81.04	\$83.49	\$91.41	\$103.79	\$111.38	\$119.16	\$89.23
125mm	\$98.49	\$94.71	\$97.41	\$108.72	\$126.94	\$137.78	\$148.89	\$105.60
150mm	\$98.49	\$94.71	\$97.41	\$108.72	\$126.94	\$137.78	\$148.89	\$103.73
225mm	\$123.47	\$117.80	\$119.98	\$137.88	\$153.42	\$169.67	\$186.33	\$133.20
300mm	\$141.38	\$133.82	\$137.36	\$159.97	\$179.02	\$200.69	\$222.91	\$153.73

# Round Downpipe Accessories



## T Bracket (.55mm) & Clip (.55mm) - price per set

Diam	C/bond	Zinc	Gal	Ultra	Metallic	304 2b	316 2b	Matt	
75mm	\$22.45	\$22.25	\$22.29	\$22.91	\$23.29	\$23.87	\$24.48	\$22.74	
90mm	\$23.39	\$23.18	\$23.23	\$23.84	\$24.22	\$24.81	\$25.41	\$23.67	
100mm	\$24.32	\$24.12	\$24.16	\$24.77	\$25.15	\$25.74	\$26.34	\$24.60	
125mm	\$26.57	\$26.28	\$26.35	\$27.19	\$27.72	\$28.53	\$29.37	\$26.96	
150mm	\$28.43	\$28.15	\$28.21	\$29.06	\$29.59	\$30.40	\$31.23	\$28.83	
225mm	\$35.57	\$35.16	\$35.26	\$36.48	\$37.24	\$38.41	\$39.62	\$36.14	
300mm	\$43.65	\$43.11	\$43.23	\$44.83	\$45.83	\$47.36	\$48.94	\$44.39	

## T Bracket (3mm Gal - UNCOATED) & Clip (.55mm) - price per set

Diam	C/bond	Zinc	Gal	Ultra	Metallic	304 2b	316 2b	Matt	
75mm	\$39.56	\$39.42	\$39.45	\$39.87	\$40.14	\$45.56	\$45.98	\$39.76	
90mm	\$39.56	\$39.42	\$39.45	\$39.87	\$40.14	\$45.56	\$45.98	\$39.76	
100mm	\$39.56	\$39.42	\$39.45	\$39.87	\$40.14	\$45.56	\$45.98	\$39.76	
125mm	\$46.16	\$45.97	\$46.01	\$46.58	\$46.93	\$55.00	\$55.55	\$46.42	
150mm	\$46.16	\$45.97	\$46.01	\$46.58	\$46.93	\$55.00	\$55.55	\$46.42	
225mm	\$49.25	\$48.97	\$49.03	\$49.88	\$50.41	\$61.26	\$62.09	\$49.65	
300mm	\$57.95	\$57.57	\$57.65	\$58.78	\$59.48	\$73.12	\$74.23	\$58.47	

## Clip Only Price - .55mm Material

Diam	C/bond	Zinc	Gal	Ultra	Metallic	304 2b	316 2b	Matt	
75mm	\$11.23	\$11.12	\$11.15	\$11.45	\$11.64	\$11.94	\$12.24	\$11.37	
90mm	\$11.69	\$11.59	\$11.61	\$11.92	\$12.11	\$12.40	\$12.70	\$11.84	
100mm	\$12.16	\$12.06	\$12.08	\$12.39	\$12.58	\$12.87	\$13.17	\$12.30	
125mm	\$13.28	\$13.14	\$13.17	\$13.60	\$13.86	\$14.27	\$14.68	\$13.48	
150mm	\$14.22	\$14.08	\$14.11	\$14.53	\$14.79	\$15.20	\$15.62	\$14.41	
225mm	\$17.79	\$17.58	\$17.63	\$18.24	\$18.62	\$19.21	\$19.81	\$18.07	
300mm	\$21.82	\$21.56	\$21.62	\$22.42	\$22.91	\$23.68	\$24.47	\$22.20	



## Zincalume Stock Drops - Punched

90mm diam	
\$10.00	EACH

100mm diam	
\$10.00	EACH

150mm diam	
\$13.20	EACH

# Round Downpipe Accessories



## Fabricated Round Drop - up to 150mm long

Diam	C/bond	Zinc	Gal	Ultra	Metallic	304 2b	316 2b	Matt	
75mm	\$30.60	\$30.81	\$30.93	\$30.44	\$30.48	\$31.21	\$31.64	\$32.09	
90mm	\$23.49	\$23.81	\$24.00	\$23.27	\$23.32	\$24.42	\$25.07	\$25.73	
100mm	\$23.86	\$24.28	\$24.53	\$23.56	\$23.62	\$25.09	\$25.96	\$26.84	
125mm	\$24.22	\$24.75	\$25.06	\$23.84	\$23.93	\$25.76	\$26.84	\$27.96	
150mm	\$24.22	\$24.75	\$25.06	\$23.84	\$23.93	\$25.76	\$26.84	\$27.96	
225mm	\$29.05	\$29.89	\$30.39	\$28.44	\$28.58	\$31.51	\$33.24	\$35.02	
300mm	\$33.51	\$34.56	\$35.18	\$32.76	\$32.92	\$36.59	\$38.76	\$40.98	

## Fabricated Round Drop - up to 500mm long

Diam	C/bond	Zinc	Gal	Ultra	Metallic	304 2b	316 2b	Matt	
75mm	\$45.89	\$46.21	\$46.40	\$45.67	\$45.72	\$46.82	\$47.47	\$48.13	
90mm	\$35.24	\$35.71	\$35.99	\$34.90	\$34.98	\$36.63	\$37.60	\$38.60	
100mm	\$35.79	\$36.42	\$36.79	\$35.33	\$35.43	\$37.63	\$38.93	\$40.27	
125mm	\$36.33	\$37.12	\$37.59	\$35.77	\$35.89	\$38.64	\$40.27	\$41.93	
150mm	\$36.33	\$37.12	\$37.59	\$35.77	\$35.89	\$38.64	\$40.27	\$41.93	
225mm	\$43.57	\$44.83	\$45.58	\$42.67	\$42.87	\$47.27	\$49.87	\$52.53	
300mm	\$50.27	\$51.84	\$52.78	\$49.13	\$49.38	\$54.88	\$58.13	\$61.47	



## Fabricated Round Downpipe Spreader - using up to 2 metres of pipe

Diam		C/bond	Zinc	Gal	Ultra	Metallic	304 2b	316 2b	Matt
75mm		\$171.20	\$166.67	\$171.40	\$184.97	\$212.07	\$225.07	\$238.40	\$181.23
90mm		\$165.92	\$160.93	\$165.77	\$180.69	\$204.90	\$219.20	\$233.87	\$176.58
100mm		\$167.38	\$162.09	\$166.99	\$182.82	\$207.59	\$222.76	\$238.31	\$178.45
125mm		\$196.98	\$189.42	\$194.82	\$217.43	\$253.89	\$275.56	\$297.78	\$211.20
150mm		\$196.98	\$189.42	\$194.82	\$217.43	\$253.89	\$275.56	\$297.78	\$207.47
225mm		\$246.93	\$235.60	\$239.97	\$275.75	\$306.83	\$339.33	\$372.67	\$266.40
300mm		\$282.76	\$267.64	\$274.71	\$319.93	\$358.04	\$401.38	\$445.82	\$307.47

# Rectangle / Square Downpipe

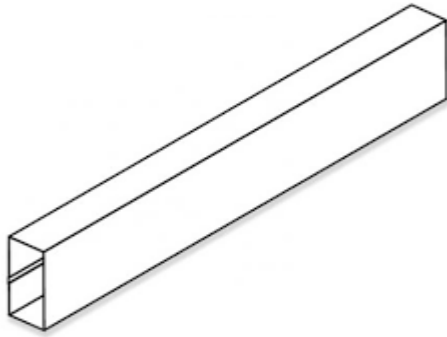

# Up to 4 metre Lengths

# Riveted Bends to make offset

# Tapered downpipe

# Clips

# Downpipe is charged per metre with 1 metre minimum charge

# Standard Pipe lead Time is 2 Working Days, offsets longer

## .55mm Material - Price per lineal Metre

Size	C/bond	Zinc	Gal	Ultra	Metallic	304 2b	316 2b	Matt	
75mm x 75mm	\$31.63	\$29.13	\$32.48	\$39.95	\$44.58	\$51.73	\$59.07	\$37.89	
100mm x 75mm	\$31.63	\$29.13	\$32.48	\$39.95	\$44.58	\$51.73	\$59.07	\$37.89	
100mm x 50mm	\$31.63	\$29.13	\$32.48	\$39.95	\$44.58	\$51.73	\$59.07	\$37.89	
100mm x 100mm	\$41.56	\$37.78	\$41.41	\$52.72	\$59.74	\$70.58	\$81.69	\$49.60	
100mm x 150mm	\$41.56	\$37.78	\$41.41	\$52.72	\$59.74	\$70.58	\$81.69	\$49.60	
150mm x 150mm	\$50.67	\$45.00	\$49.05	\$66.01	\$76.55	\$92.80	\$109.47	\$61.33	
200mm x 200mm	\$58.96	\$52.34	\$56.60	\$76.39	\$88.69	\$107.64	\$127.09	\$70.93	
250mm x 250mm	\$67.24	\$59.69	\$64.16	\$86.77	\$100.82	\$122.49	\$144.71	\$80.53	

## Adjustable Offset - .55mm Material - Price per unit

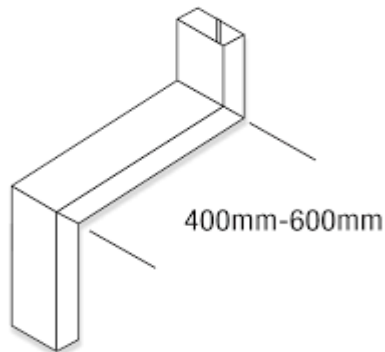

Size	C/bond	Zinc	Gal	Ultra	Metallic	304 2b	316 2b	Matt	
75mm x 75mm	\$175.25	\$170.27	\$176.97	\$191.89	\$201.17	\$230.40	\$245.07	\$187.78	
100mm x 75mm	\$175.25	\$170.27	\$176.97	\$191.89	\$201.17	\$230.40	\$245.07	\$187.78	
100mm x 50mm	\$175.25	\$170.27	\$176.97	\$191.89	\$201.17	\$230.40	\$245.07	\$187.78	
100mm x 100mm	\$195.11	\$187.56	\$194.82	\$217.43	\$231.49	\$268.09	\$290.31	\$211.20	
100mm x 150mm	\$210.04	\$202.49	\$209.76	\$232.37	\$246.42	\$290.49	\$312.71	\$226.13	
150mm x 150mm	\$228.27	\$216.93	\$225.03	\$258.95	\$280.03	\$334.93	\$368.27	\$249.60	
200mm x 200mm	\$267.24	\$254.02	\$262.54	\$302.11	\$326.71	\$374.62	\$413.51	\$291.20	
250mm x 250mm	\$295.82	\$280.71	\$289.64	\$334.87	\$362.98	\$416.31	\$460.76	\$322.40	

# Rectangle / Square Downpipe

## Offset - Fabricated to Size



### Pricing Notes

\* Allow for the amount of pipe required at per metre rates from previous page

\* Add Price for 2 x Riveted Bends as per below (or as many bends as required)

## .55mm Material - Price Per Each Riveted Bend - Labour Only

### Pipe Size

	75 x 75	100 x 75	100 x 50	100 x 100	100 x 150	150 x 150	200 x 200	250 x 250
<b>CB ZA GAL</b>	\$56.00	\$56.00	\$56.00	\$56.00	\$63.47	\$63.47	\$74.67	\$80.67
<b>SS</b>	\$63.47	\$63.47	\$63.47	\$63.47	\$74.67	\$74.67	\$79.67	\$85.67

## Riveted Elbow - 300mm x 300mm



Size	C/bond	Zinc	Gal	Ultra	Metallic	304 2b	316 2b	Matt
<b>75mm x 75mm</b>	\$87.63	\$85.13	\$88.48	\$95.95	\$100.58	\$115.20	\$122.53	\$93.89
<b>100mm x 75mm</b>	\$87.63	\$85.13	\$88.48	\$95.95	\$100.58	\$115.20	\$122.53	\$93.89
<b>100mm x 50mm</b>	\$87.63	\$85.13	\$88.48	\$95.95	\$100.58	\$115.20	\$122.53	\$93.89
<b>100mm x 100mm</b>	\$97.56	\$93.78	\$97.41	\$108.72	\$115.74	\$134.04	\$145.16	\$105.60
<b>100mm x 150mm</b>	\$105.02	\$101.24	\$104.88	\$116.18	\$123.21	\$145.24	\$156.36	\$113.07
<b>150mm x 150mm</b>	\$114.13	\$108.47	\$112.52	\$129.48	\$140.02	\$167.47	\$184.13	\$124.80
<b>200mm x 200mm</b>	\$133.62	\$127.01	\$131.27	\$151.05	\$163.35	\$187.31	\$206.76	\$145.60
<b>250mm x 250mm</b>	\$147.91	\$140.36	\$144.82	\$167.43	\$181.49	\$208.16	\$230.38	\$161.20

# Rectangle / Square Downpipe Accessories



### Clip Only Price - .55mm Material

Size	C/bond	Zinc	Gal	Ultra	Metallic	304 2b	316 2b	Matt	
75mm x 75mm	\$11.23	\$11.12	\$11.15	\$11.45	\$11.64	\$11.94	\$12.24	\$11.37	
100mm x 75mm	\$11.69	\$11.59	\$11.61	\$11.92	\$12.11	\$12.40	\$12.70	\$11.84	
100mm x 50mm	\$12.16	\$12.06	\$12.08	\$12.39	\$12.58	\$12.87	\$13.17	\$12.30	
100mm x 100mm	\$13.28	\$13.14	\$13.17	\$13.60	\$13.86	\$14.27	\$14.68	\$13.48	
100mm x 150mm	\$14.22	\$14.08	\$14.11	\$14.53	\$14.79	\$15.20	\$15.62	\$14.41	
150mm x 150mm	\$17.79	\$17.58	\$17.63	\$18.24	\$18.62	\$19.21	\$19.81	\$18.07	
200mm x 200mm	\$21.82	\$21.56	\$21.62	\$22.42	\$22.91	\$23.68	\$24.47	\$22.20	
250mm x 250mm	\$25.10	\$24.79	\$24.86	\$25.78	\$26.35	\$27.23	\$28.14	\$25.52	



### # Stock Zinalume Drop to Suit 100mm x 75mm Downpipe

<b>\$10.00</b>	<b>EACH</b>
----------------	-------------



### Fabricated Drop - up to 100mm long

Size	C/bond	Zinc	Gal	Ultra	Metallic	304 2b	316 2b	Matt	
75mm x 75mm	\$23.49	\$23.81	\$24.00	\$23.27	\$23.32	\$24.42	\$25.07	\$25.73	
100mm x 75mm	\$23.49	\$23.81	\$24.00	\$23.27	\$23.32	\$24.42	\$25.07	\$25.73	
100mm x 50mm	\$23.86	\$24.28	\$24.53	\$23.56	\$23.62	\$25.09	\$25.96	\$26.84	
100mm x 100mm	\$24.22	\$24.75	\$25.06	\$23.84	\$23.93	\$25.76	\$26.84	\$27.96	
100mm x 150mm	\$24.22	\$24.75	\$25.06	\$23.84	\$23.93	\$25.76	\$26.84	\$27.96	
150mm x 150mm	\$29.05	\$29.89	\$30.39	\$28.44	\$28.58	\$31.51	\$33.24	\$35.02	
200mm x 200mm	\$33.51	\$34.56	\$35.18	\$32.76	\$32.92	\$36.59	\$38.76	\$40.98	
250mm x 250mm	\$37.51	\$38.56	\$39.18	\$36.76	\$36.92	\$40.59	\$42.76	\$44.98	



# Spiral Lockseam Downpipe



# Up to 8 metre Lengths

# 90mm diam to 229mm diam

# Riveted Bends to make offset

# T brackets & Clips Available

# Set up Charge applies if under 12 metres in order - \$350.00

# Standard Pipe lead Time is 10 - 15 Working Days, offsets longer

## .6mm Downpipe - Price per lineal Metre

Diam	Galvabond	T Bracket (40 x .55mm) & Clip (40 x .55)
90mm	\$35.60	\$24.16
102mm	\$37.60	\$26.35
152mm	\$45.60	\$28.21
203mm	\$65.60	\$35.26
229mm	\$77.60	\$43.23

## .8mm Downpipe - Price per lineal Metre

Diam	Zincalume	Galvabond	T Bracket (40 x 3mm) & Clip (40 x .55)
90mm	\$37.60	\$43.60	\$39.45
102mm	\$43.60	\$45.60	\$46.01
152mm	\$55.60	\$59.60	\$46.01
203mm	\$79.60	\$81.60	\$49.03
229mm	\$91.60	\$95.60	\$57.65

## 1mm Downpipe - Price per lineal Metre

Diam	Zincalume	Galvabond
90mm	\$45.60	\$49.60
102mm	\$49.60	\$51.60
152mm	\$65.60	\$69.60
203mm	\$91.60	\$91.60
229mm	\$105.60	\$109.60

## Riveted Bend - labour rate

Diam	.6mm	.8mm	1mm
90mm	\$67.20	\$89.60	\$112.00
102mm	\$78.40	\$100.80	\$123.20
152mm	\$89.60	\$115.73	\$138.13
203mm	\$100.80	\$130.67	\$156.80
229mm	\$112.00	\$141.87	\$168.00

# Heavy Duty Spiral Lockseam Downpipe

# Up to 8 metre Lengths

# 102mm diam to 229mm diam

# Welded Bends to make offset

# T brackets & Clips Available

# Set up Charge applies if under 12 metres in order - \$350.00

# Standard Pipe lead Time is 10 - 15 Working Days, offsets longer

## 1.2mm Downpipe - Price per lineal Metre

Diam	Zincalume	Galvabond	T Bracket (40 x 3mm) & Clip (40 x .55)
102mm	\$65.60	\$59.60	\$46.01
152mm	\$97.60	\$81.60	\$46.01
203mm	\$125.60	\$107.60	\$49.03
229mm	\$145.60	\$125.60	\$57.65

## 1.6mm Downpipe - Price per lineal Metre

Diam	Galvabond	T Bracket (3mm) & Welded Lug (3mm)
102mm	\$73.60	\$57.93
152mm	\$97.60	\$65.63
203mm	\$125.60	\$80.80
229mm	\$149.60	\$91.00

## Welded Bend - labour rate

Diam	1.2mm	1.6mm
102mm	\$149.33	\$160.53
152mm	\$168.00	\$179.20
203mm	\$186.67	\$201.60
229mm	\$205.33	\$224.00

# Stainless Steel Spiral Lockseam Downpipe

# Up to 8 metre Lengths

# 90mm diam to 229mm diam

# Riveted Bends to make offset

# T brackets & Clips Available

**## Machine Marks / Scuffing will be visible from the Manufacturing Process ##**

**# Set up Charge applies if under 12 metres in order - \$350.00**

**# Standard Pipe lead Time is 10 - 15 Working Days, offsets longer**

### .6mm Downpipe - Price per lineal Metre

Diam		304 2b finish	316 2b finish	.55mm T & Clip
90mm		\$65.60	\$77.60	\$26.34
102mm		\$77.60	\$95.60	\$29.37
152mm		\$109.60	\$129.60	\$31.23
203mm		\$145.60	\$169.60	\$39.62
229mm		\$165.60	\$205.60	\$48.94

### .9mm Downpipe - Price per lineal Metre

Diam		304 2b finish	316 2b finish	3mm T & .55mm Clip
90mm		\$105.60	\$129.60	\$45.98
102mm		\$125.60	\$149.60	\$55.55
152mm		\$169.60	\$205.60	\$55.55
203mm		\$215.60	\$255.60	\$62.09
229mm		\$255.60	\$315.60	\$74.23

### Riveted Bend - labour rate

Diam		.6mm	.9mm	
90mm		\$89.60	\$112.00	
102mm		\$100.80	\$123.20	
152mm		\$115.73	\$138.13	
203mm		\$130.67	\$156.80	
229mm		\$141.87	\$168.00	

# Hot Dip Galvanised Spiral Welded Downpipe

# Up to 8 metre Lengths

# 90mm diam to 229mm diam

# Welded Bends to make offset

# T brackets & Clips Available

# Set up Charge applies if under 12 metres in order - \$350.00

# Standard Pipe lead Time is 20 Working Days, offsets longer

## 1.6mm Downpipe - Price per lineal Metre

Mild Steel + Hot Dip Galvanised				
Diam	Pipe	Welded Bend	T Bracket (5mm) & Welded Lug (5mm)	
90mm	\$77.47	\$130.67	\$54.53	
102mm	\$81.47	\$149.33	\$60.93	
152mm	\$112.47	\$168.00	\$74.80	
203mm	\$151.47	\$186.67	\$83.20	
229mm	\$178.97	\$205.33	\$83.20	

## 2mm Downpipe - Price per lineal Metre

Mild Steel + Hot Dip Galvanised				
Diam	Pipe	Welded Bend	T Bracket (5mm) & Welded Lug (5mm)	
90mm	\$92.97	\$141.87	\$54.53	
102mm	\$96.97	\$160.53	\$60.93	
152mm	\$139.47	\$179.20	\$74.80	
203mm	\$186.47	\$201.60	\$83.20	
229mm	\$223.72	\$224.00	\$83.20	

## 3mm Downpipe - Price per lineal Metre

Mild Steel + Hot Dip Galvanised				
Diam	Pipe	Welded Bend	T Bracket (5mm) & Welded Lug (5mm)	
90mm	\$129.97	\$168.00	\$54.53	
102mm	\$141.72	\$186.67	\$60.93	
152mm	\$197.72	\$205.33	\$74.80	
203mm	\$267.97	\$224.00	\$83.20	
229mm	\$298.97	\$246.40	\$83.20	

# Stainless Steel Spiral Welded Downpipe

# Up to 8 metre Lengths

# 90mm diam to 229mm diam

# Welded Bends to make offset

# T brackets & Clips Available

**## Machine Marks / Scuffing will be visible from the Manufacturing Process ##**

**# Set up Charge applies if under 12 metres in order - \$350.00**

**# Standard Pipe lead Time is 15 Working Days, offsets longer**

## 1.2mm Downpipe - Price per lineal Metre

Diam	304 2b finish	316 2b finish	Welded Bend	T bkt & Clip
90mm	\$87.47	\$97.47	\$112.00	\$57.93
102mm	\$87.47	\$97.47	\$112.00	\$65.63
152mm	\$127.47	\$147.47	\$149.33	\$80.80
203mm	\$161.47	\$187.47	\$186.67	\$91.00
229mm	\$197.47	\$257.47	\$186.67	\$91.00

## 1.6mm Downpipe - Price per lineal Metre

Diam	304 2b finish	316 2b finish	Welded Bend	T bkt & Clip
90mm	\$117.47	\$167.47	\$112.00	57.93
102mm	\$117.47	\$167.47	\$112.00	65.63
152mm	\$177.47	\$227.47	\$149.33	80.80
203mm	\$227.47	\$307.47	\$186.67	91.00
229mm	\$267.47	\$357.47	\$186.67	91.00

## 2mm Downpipe - Price per lineal Metre

Diam	304 2b finish	316 2b finish	Welded Bend	T bkt & Clip
90mm	\$141.47	\$187.47	\$112.00	69.33
102mm	\$141.47	\$187.47	\$112.00	82.07
152mm	\$207.47	\$267.47	\$149.33	106.30
203mm	\$267.47	\$357.47	\$186.67	117.53
229mm	\$317.47	\$407.47	\$186.67	117.53

# Ridge Vent System



Open Top



Closed Top

# Open Top from 300mm Throat to 1200mm Throat

# Closed Top from 300mm Throat to 600mm Throat

# Supplied in Kit Form

# Standard Lead Time is 10 Working Days

# Engineered Data available - Open Top Version Only

## .55mm Material - Price Per Lineal Metre

### Small Quantity - Less Than 10 Metres

Throat	Open Top		Closed Top	
	c/bond	zinc	c/bond	zinc
300mm	\$445.08	\$418.48	\$316.60	\$293.65
450mm	\$609.09	\$555.09	\$479.09	\$443.54
600mm	\$814.29	\$748.36	\$606.42	\$562.00
750mm	\$1,008.20	\$949.49		
900mm	\$1,305.41	\$1,238.69		
1200mm	\$1,794.82	\$1,716.50		

### Quantity - Greater Than 10 Metres

Throat	Open Top		Closed Top	
	c/bond	zinc	c/bond	zinc
300mm	\$422.83	\$397.56	\$300.77	\$278.97
450mm	\$578.64	\$527.33	\$455.13	\$421.36
600mm	\$773.57	\$710.94	\$576.10	\$533.90
750mm	\$957.79	\$902.02		
900mm	\$1,240.14	\$1,176.76		
1200mm	\$1,705.08	\$1,630.68		

# Fixed Metal Louvres - Side Profiles

## 2 Stage Louvre

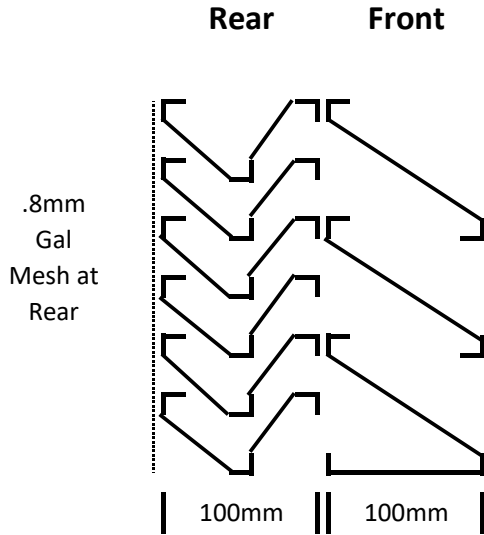

## Basic 2 Stage Louvre

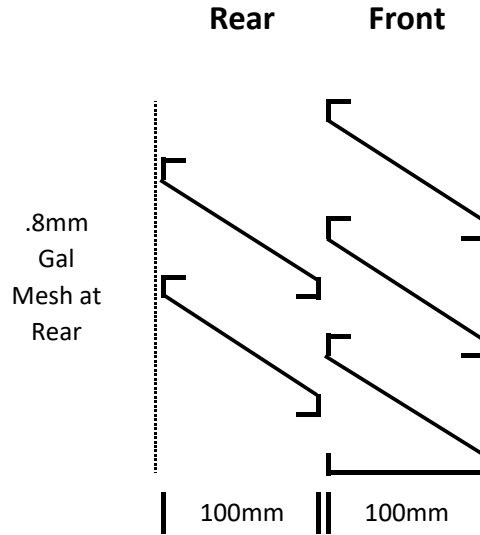

## Standard Single Stage Louvre

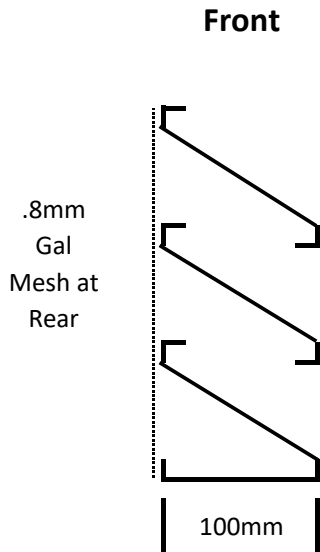

## Stepped Single Stage Louvre

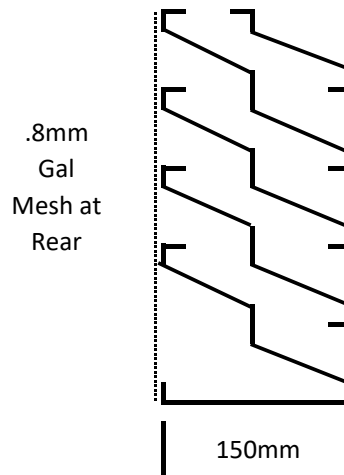

Louvres are charged per square metre - 1 metre minimum charge per Louvre

# Fixed Louvres



- # 100mm wide Bank
- # .8mm Gal mesh at Back
- # .55mm Blades and Channel
- # Can add Perimeter Flashing
- # **Standard Lead Time 5 Working days**
- # **Minimum Charge 1m<sup>2</sup>**

## Price Per Square Metre - .55mm Material

Version	C/bond	Zinc	Gal	Ultra	Metallic	Matt	
Standard Single Stage	\$381.03	\$355.25	\$378.29	\$461.39	\$513.04	\$438.48	
Stepped Single Stage	\$571.55	\$532.88	\$567.44	\$692.08	\$769.56	\$657.72	
Basic 2 Stage	\$857.33	\$799.31	\$851.16	\$1,038.12	\$1,154.34	\$986.58	
True 2 stage	\$1,333.62	\$1,243.38	\$1,324.02	\$1,614.86	\$1,795.65	\$1,534.68	

## Extra Per Square Metre - Add Angle Flashing to Perimeter

C/bond	Zinc	Gal	Ultra	Metallic	Matt	
\$126.31	\$121.02	\$125.92	\$141.75	\$151.59	\$137.39	

## OTHER UPGRADES

Change to Stainless Steel Mesh at Back - Extra per square metre

\$161.73



# Curved Flashings

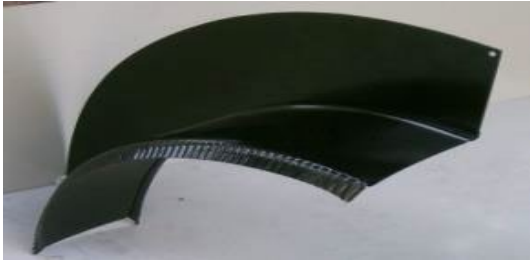

## Single Curves - Aprons and Barge - Per Lineal Metre

Zincalume	\$109.33
Colorbond	\$118.40
Matt / Ultra / Metallic	\$138.47



## Double Curves - Parapets - Per Lineal Metre

Zincalume	\$174.00
Colorbond	\$185.33
Matt / Ultra / Metallic	\$210.42

## Additional Curve - Over and Above the Double - Per Lineal Metre

Zincalume	\$107.78
Colorbond	\$111.56
Matt / Ultra / Metallic	\$126.94

# Safe Trays

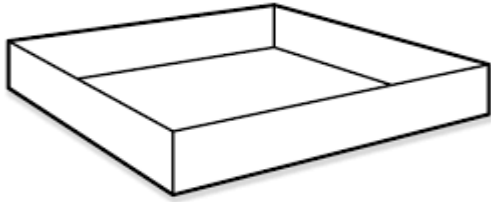

## # Safe Trays

### .55mm Material - Price Per Each - 50mm sides

Square	C/bond	Zinc	Gal	Ultra	Metallic	304 2b	316 2b	Matt	
400mm	\$66.93	\$64.67	\$65.17	\$71.95	\$76.17	\$82.67	\$89.33	\$70.08	
450mm	\$66.93	\$64.67	\$65.17	\$71.95	\$76.17	\$82.67	\$89.33	\$70.08	
500mm	\$70.58	\$67.56	\$68.22	\$77.27	\$82.89	\$91.56	\$100.44	\$74.77	
550mm	\$70.58	\$67.56	\$68.22	\$77.27	\$82.89	\$91.56	\$100.44	\$74.77	
600mm	\$74.22	\$70.44	\$71.28	\$82.58	\$89.61	\$100.44	\$111.56	\$79.47	
700mm	\$85.33	\$80.80	\$81.80	\$95.37	\$103.80	\$116.80	\$130.13	\$91.63	
800mm	\$102.00	\$94.89	\$96.06	\$111.88	\$121.72	\$136.89	\$152.44	\$107.52	
900mm	\$118.58	\$111.02	\$112.69	\$135.30	\$149.36	\$171.02	\$193.24	\$129.07	
1000mm	\$137.07	\$128.00	\$130.00	\$157.13	\$174.00	\$200.00	\$226.67	\$149.65	
1090mm*	\$159.20	\$147.87	\$150.37	\$184.28	\$205.37	\$237.87	\$271.20	\$174.93	

#### Pricing Notes

\* If 100mm sides, go up to next size for pricing

\* If unequal sides - use the biggest side for pricing

\* If larger than 1090mm square with 50mm side - will require lockseam join - Price on Request



## # Copper Safe Trays

### .55mm Material - Price Per Each - 50mm sides

Square	Each	Square	Each
400mm	\$229.73	700mm	\$347.47
450mm	\$245.62	800mm	\$379.24
500mm	\$261.51	900mm	\$504.44
550mm	\$277.40	1000mm	\$586.67
600mm	\$293.29	1090mm*	\$738.00

#### Pricing Notes

\* As per safe trays top of page

# Other Items

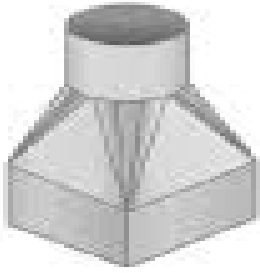

## # Transitions / Reducers

# Square to Round

# Rectangle to Round

# Up to 300mm long overall

### .55mm Material - Price Per Each

Pipe Sizes	C/bond	Zinc	Gal	Ultra	Metallic	304 2b	316 2b	Matt	
Up to 150mm	\$133.42	\$125.11	\$126.94	\$151.82	\$167.28	\$191.11	\$215.56	\$144.96	
151 to 300mm	\$170.31	\$158.22	\$160.89	\$197.07	\$219.56	\$254.22	\$289.78	\$187.09	

## Lockseam Trays

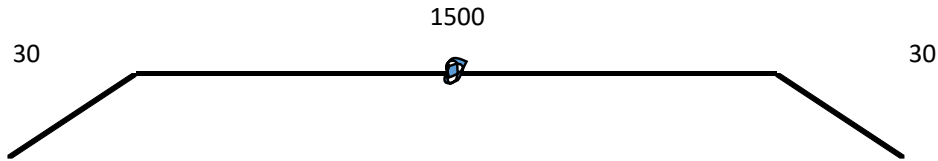

For anything over 1200mm girth and 1200mm long a Lockseam joint would be required.

For example to price above: total girth is 1575mm (1560mm + 15mm for joint)

charged as	1200mm girth x 2 bends		
plus	400mm flat		
plus	<b>Lockseam Joint</b>	<b>\$14.93</b>	<b>per metre</b>

## Uprand Trays / Corner Notching

Price per corner to Notch prior to Folding **\$11.20 per corner**

---

# Other Items

---

## 3mm Galvabond Folded Downpipe Protectors

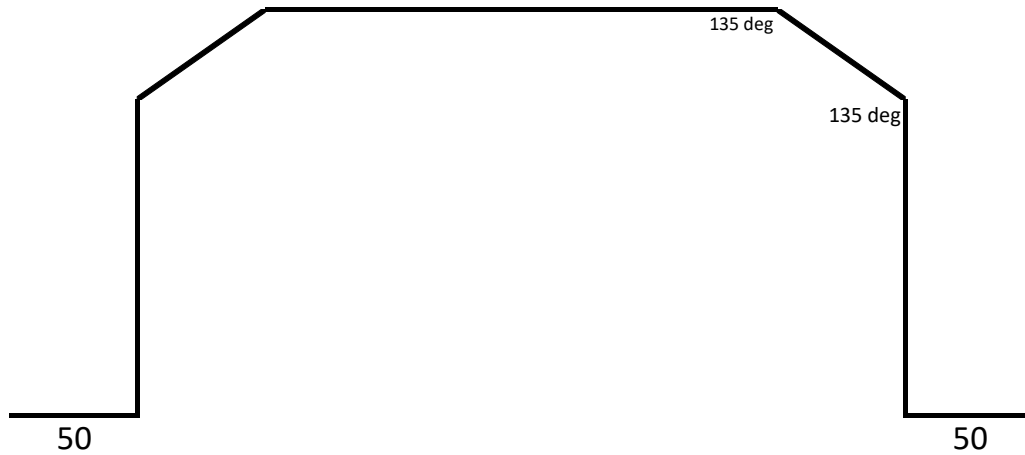

# 3 holes punched in each 50mm flange for fixing

3.6 metre sheets kept in stock

600 girth	\$122.07	Per Metre
900 girth	\$186.87	Per Metre
1200 girth	\$203.07	Per Metre

**Rate for 6 holes punched per length**

**\$46.67**

**Per Unit**

## MESH PRODUCTS 12mm X 12mm SQUARE

SUMP GUARDS				
	.8mm GAL	1.3mm GAL	1.3mm 304 SS	1.3mm 316 SS
300mm x 300mm x 150mm	62.30	82.17	104.67	110.67
400mm x 400mm x 150mm	64.82	85.17	116.67	125.07
500mm x 500mm x 150mm	86.22	107.08	148.33	159.33
600mm x 600mm x 150mm	88.95	110.33	161.33	174.93
700mm x 700mm x 150mm	92.52	114.58	178.33	195.33
800mm x 800mm x 150mm	114.33	137.00	212.00	232.00
900mm x 900mm x 150mm	114.33	137.00	212.00	232.00
DROP GUARDS				
	.8mm GAL	1.3mm GAL	1.3mm 304 SS	1.3mm 316 SS
100mm diam	38.59	38.83	43.33	44.53
150mm diam	46.90	47.30	54.80	56.80
225mm diam	59.15	59.75	71.00	74.00
FLASHINGS				
	.8mm GAL	1.3mm GAL	1.3mm 304 SS	1.3mm 316 SS
0 - 200mm Girth				
Flat	9.80	12.47	27.47	31.47
1 bend	11.67	14.33	29.33	33.33
2 bend	15.40	16.20	31.20	35.20
3 bend	17.27	18.07	33.07	37.07
4 bend	19.13	19.93	34.93	38.93
201mm to 400mm Girth				
Flat	12.53	15.72	40.47	47.07
1 bend	14.40	17.58	42.33	48.93
2 bend	18.13	19.45	44.20	50.80
3 bend	20.00	21.32	46.07	52.67
4 bend	21.86	23.18	47.93	54.53
401mm to 600mm Girth				
Flat	16.10	19.97	57.47	67.47
1 bend	17.97	21.83	59.33	69.33
2 bend	21.70	23.70	61.20	71.20
3 bend	23.57	25.57	63.07	73.07
4 bend	25.43	27.43	64.93	74.93
601mm to 900mm Girth				
Flat	22.93	28.09	89.97	106.47
1 bend	24.79	29.96	91.83	108.33
2 bend	28.53	31.83	93.70	110.20
3 bend	30.39	33.69	95.57	112.07
4 bend	32.26	35.56	97.43	113.93
901mm to 1200mm Girth				
Flat	26.60	32.47	107.47	127.47
1 bend	28.47	34.33	109.33	129.33
2 bend	32.20	36.20	111.20	131.20
3 bend	34.07	38.07	113.07	133.07
4 bend	35.93	39.93	114.93	134.93

# DOWNPIPE PROTECTOR SIZE OPTIONS

	Circular Hollow Section (CHS)				Spiral Welded Pipe	
	Pre Galvanised		Hot Dip Galvanised		Hot Dip Galvanised	
To Go Over Pipe Size	Outside Diam (mm)	Wall thickness (mm)	Outside Diam (mm)	Wall Thickness (mm)	Outside Diam (mm)	Wall Thickness (mm)
90mm C/bond	101.6	2.6 3.2	101.6	2.6 3.2	102	1.6 2.0 3.0
100mm C/bond	114.3	3.2 3.6	114.3	3.2 3.6	127	1.6 2.0 3.0
125mm C/bond	139.7	3.0 3.5	139.7	3.0 3.5	152	1.6 2.0 3.0
	139.7	5.0 5.4	139.7	5.0 5.4		
150mm C/bond	165.1	3.0 3.5	165.1	3.0 3.5	178	1.6 2.0 3.0
	165.1	5	165.1	5		
225mm C/bond	N/A	N/A	273.5	5	254	1.6 2.0 3.0
100mm PVC (114 OD)	139.7	3.0 3.5	139.7	3.0 3.5	127	1.6 2.0 3.0
	139.7	5.0 5.4	139.7	5.0 5.4		
150mm PVC (168 OD)	N/A	N/A	219	5	178	1.6 2.0 3.0
200mm PVC (219 OD)	N/A	N/A	273.5	5	229	1.6 2.0 3.0
250mm PVC (273 OD)	N/A	N/A	323	6	305	1.6 2.0 3.0

**All Pipe Options are Subject to Stock Availability**

**Lead times are Subject to Pipe Manufacturing, CSM Fabrication and Galvanising times if Applicable**

## BOLLARDS - CHS DOWNPIPE PROTECTOR

	Pre Galvanised Pipe		Hot Dip Galvanised Pipe	
Per Set	114.3mm OD x 3.6mm Wall	165.1mm OD x 3.5mm Wall	114.3mm OD x 3.6mm Wall	165.1mm OD x 3.5mm Wall
Up to 1625mm long	324.83	418.50	411.93	542.70
1626 to 2170mm long	377.33	496.00	494.27	659.87
2171 to 3250mm long	482.33	651.00	666.73	905.80
3251 to 6500mm long	797.33	1116.00	1176.33	1632.00
<b>Extras - Factory Welded</b>				
Welded Bend	168.00	224.00	168.00	224.00
Welded Sleeve	149.33	156.80	149.33	156.80

**Per set includes:**

2 x Welded Lugs to pipe (50mm x 5mm)

2 x Loose T Brackets (50mm x 5mm)

### Standard Lead Times

Pre Galvanised 7 Days

Hot Dip Galvanised 3 - 5 weeks



**Pre Galvanised Can often come out rough and dirty**

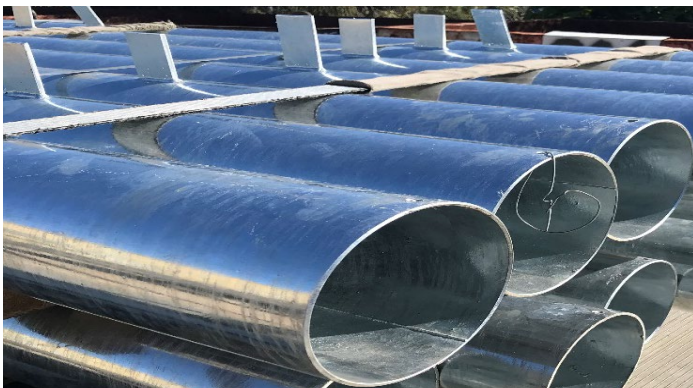

**Hot Dip Galvanised is a much cleaner finish**





# Stainless Steel Welded Products





## Stainless Steel Products

### PREVENTION OF TEA STAINING

This document is to become a standard attachment to all stainless steel quotes and accompanies an *ASSDA Technical Bulletin - Preventing Coastal Corrosion (Tea Staining) February 2010*.

It may be in your best interest to add this document or similar to your maintenance manuals to pass onto builders.

**Tea Staining can only be prevented via regular maintenance - the duration required is dependant on many factors including: location to marine, atmospheric conditions and the finish of materials chosen.**

The smoother the finish of material the more resistant it is to tea staining.

List of finishes from most resistant to least resistant

Electropolished

No 8 Finish - Mirror (1000 grit)

2B Finish

Bright Annealed Finish

No 4 Finish 320 - 400 grit

#### **Gnerally what we stock and supply**

Gutters & Flashings	2B and No 4 Finish
.55mm Downpipe	2B and No 4 Finish
1.6mm Tube	No 4 Finish
Flat bar brackets	No 4 Finish
Laser cut brackets	2B and No 4 Finish

If products are specified outside of our regular finishes above - longer lead times may apply

**It is very important that we stress the most critical preventative tool to avoiding tea staining is regular cleaning of the products once installed**

**Futher information is available at [www.assda.asn.au](http://www.assda.asn.au)**

# Factory Welded Sumps



## Welded Sump into Gutter - Price per each

Size	1.2mm 304	1.2mm 316	1.6mm 304	1.6mm 316
300mm Square	\$360.00	\$380.00	\$384.62	\$409.23
400mm Square	\$380.00	\$405.00	\$410.77	\$441.54
500mm Square	\$400.00	\$430.00	\$436.92	\$473.85
600mm Square	\$448.67	\$486.17	\$494.82	\$540.97
700mm Square	\$488.67	\$536.17	\$547.13	\$605.59
800mm Square	\$537.33	\$592.33	\$605.03	\$672.72
900mm Square	\$596.00	\$661.00	\$676.00	\$756.00
1000mm Square	\$656.00	\$736.00	\$754.46	\$852.92

Price Notes

- # When unequal sides - use the biggest side
- # Prices above cover up to 150mm Deep Sumps
- # If 151mm to 250mm Deep - go to next size up
- # If 251mm to 350mm Deep - go 2 sizes up

## Option for Welded Drop into Any Sump as Extra

	1.2mm 304	1.2mm 316	1.6mm 304	1.6mm 316
100 or 150mm	\$113.33	\$118.33	\$119.49	\$125.64
225mm	\$123.33	\$128.33	\$129.49	\$135.64

# Factory Welded Accessories

## Welded Stop End - Price per each

Gutter Girth	1.2mm 304	1.2mm 316	1.6mm 304	1.6mm 316
Up to 600mm	\$105.87	\$110.87	\$112.02	\$118.17
601 to 900mm	\$134.53	\$142.03	\$143.76	\$152.99
901 to 1200mm	\$173.20	\$185.70	\$188.58	\$203.97
1201 to 1500mm	\$207.84	\$222.84	\$226.30	\$244.76

## Welded Round Overflow - Price per each

Size	1.2mm 304	1.2mm 316	1.6mm 304	1.6mm 316
Up to 100mm diam	\$152.00	\$162.00	\$164.31	\$176.62
150mm diam	\$180.67	\$193.17	\$196.05	\$211.44
225mm diam	\$239.33	\$261.83	\$267.03	\$294.72
300mm diam	\$308.00	\$343.00	\$351.08	\$394.15

## Welded Square / Rectangle Spitters - Price per each

Size	1.2mm 304	1.2mm 316	1.6mm 304	1.6mm 316
100mm x 100mm	\$133.33	\$143.33	\$145.64	\$157.95
150mm x 150mm	\$143.33	\$155.83	\$158.72	\$174.10
200mm x 200mm	\$202.00	\$224.50	\$229.69	\$257.38
300mm x 300mm	\$270.67	\$305.67	\$313.74	\$356.82

## Welded Round Drop - Price per each

Size	1.2mm 304	1.2mm 316	1.6mm 304	1.6mm 316
Up to 100mm diam	\$128.33	\$137.08	\$139.10	\$149.87
150mm diam	\$152.00	\$162.00	\$164.31	\$176.62
225mm diam	\$180.67	\$193.17	\$196.05	\$211.44
300mm diam	\$209.33	\$224.33	\$227.79	\$246.26

## Welded Square / Rectangle Drop - Price per each

Size	1.2mm 304	1.2mm 316	1.6mm 304	1.6mm 316
100mm x 100mm	\$128.33	\$137.08	\$139.10	\$149.87
150mm x 150mm	\$152.00	\$162.00	\$164.31	\$176.62
200mm x 200mm	\$180.67	\$193.17	\$196.05	\$211.44
300mm x 300mm	\$209.33	\$224.33	\$227.79	\$246.26

# Factory Welded Rainheads



## Rectangular Style Rainheads

	Price per Each			
Width	1.2mm 304	1.2mm 316	1.6mm 304	1.6mm 316
300mm	\$569.33	\$604.33	\$631.08	\$674.15
400mm	\$628.00	\$673.00	\$702.05	\$757.44
500mm	\$706.67	\$766.67	\$799.18	\$873.03
600mm	\$765.33	\$835.33	\$870.15	\$956.31
750mm	\$844.00	\$929.00	\$967.28	\$1,071.90
900mm	\$941.33	\$1,041.33	\$1,083.08	\$1,206.15
1200mm	\$1,129.60	\$1,249.60	\$1,299.69	\$1,447.38

Price Notes

\* Fitted Drop is included in Price

## Conical Style Rainheads

	Price per Each			
Width	1.2mm 304	1.2mm 316	1.6mm 304	1.6mm 316
300mm	\$569.33	\$604.33	\$631.08	\$674.15
400mm	\$628.00	\$673.00	\$702.05	\$757.44
500mm	\$706.67	\$766.67	\$799.18	\$873.03
600mm	\$765.33	\$835.33	\$870.15	\$956.31
750mm	\$844.00	\$929.00	\$967.28	\$1,071.90
900mm	\$941.33	\$1,041.33	\$1,083.08	\$1,206.15
1200mm	\$1,129.60	\$1,249.60	\$1,299.69	\$1,447.38

Price Notes

\* Fitted Drop is included in Price

### Option for Overflow Hole or Fitted Overflow - Extra

	1.2mm 304	1.2mm 316	1.6mm 304	1.6mm 316
Hole Cut Only	\$74.67	\$74.67	\$74.67	\$74.67
Fitted Overflow	\$140.67	\$143.17	\$143.74	\$146.82

# Welded Rainheads



## Flat Bottom Style Rainheads

	Price per Each			
Width	1.2mm 304	1.2mm 316	1.6mm 304	1.6mm 316
300mm	\$569.33	\$604.33	\$631.08	\$674.15
400mm	\$628.00	\$673.00	\$702.05	\$757.44
500mm	\$706.67	\$766.67	\$799.18	\$873.03
600mm	\$765.33	\$835.33	\$870.15	\$956.31
750mm	\$844.00	\$929.00	\$967.28	\$1,071.90
900mm	\$941.33	\$1,041.33	\$1,083.08	\$1,206.15
1200mm	\$1,129.60	\$1,249.60	\$1,299.69	\$1,447.38

Price Notes

\* Fitted Drop is included in Price

### Option for Overflow Hole or Fitted Overflow - Extra

	1.2mm 304	1.2mm 316	1.6mm 304	1.6mm 316
Hole Cut Only	\$74.67	\$74.67	\$74.67	\$74.67
Fitted Overflow	\$140.67	\$143.17	\$143.74	\$146.82

# Welded Stainless Half Round Gutters

# Smooth Rolled Up to 2.4 metres length

# Turn in at Front as Standard

# Can Weld Lengths together to send out up to 7.2 metre length

## Price per lineal Metre

Diam	1.2mm 304	1.2mm 316		
150mm	\$87.33	\$99.83		
175mm	\$93.33	\$107.33		
200mm	\$110.80	\$127.30		
225mm	\$122.53	\$141.03		
250mm	\$146.00	\$168.50		
300mm	\$163.47	\$188.47		
350mm	\$167.20	\$192.20		
400mm	\$208.67	\$242.17		
450mm	\$239.97	\$278.49		

## Laser Cut A4 Style Brackets - 2b Stainless Steel

Diam		304	316	
150mm		\$39.46	\$46.66	
175mm		\$43.37	\$51.59	
200mm		\$48.32	\$57.96	
225mm		\$55.96	\$67.53	
250mm		\$61.91	\$75.08	
300mm		\$72.51	\$88.17	
350mm		\$87.66	\$107.20	
400mm		\$118.66	\$146.28	
450mm		\$148.74	\$183.79	

## Welded Stop Ends

Diam	1.2mm 304	1.2mm 316		
150mm	\$122.00	\$124.50		
175mm	\$122.00	\$124.50		
200mm	\$122.00	\$124.50		
225mm	\$126.00	\$129.50		
250mm	\$146.67	\$150.67		
300mm	\$150.67	\$155.67		
350mm	\$179.33	\$186.83		
400mm	\$208.00	\$218.00		
450mm	\$239.20	\$250.70		

---

# Welded Stainless Half Round Gutters

---

# Smooth Rolled Up to 2.4 metres length

# Turn in at Front as Standard

# Can Weld Lengths together to send out up to 7.2 metre length

## Welded Gutter Joint

Diam	1.2mm 304	1.2mm 316		
150mm	\$130.67	\$130.67		
175mm	\$130.67	\$130.67		
200mm	\$130.67	\$130.67		
225mm	\$130.67	\$130.67		
250mm	\$149.33	\$149.33		
300mm	\$149.33	\$149.33		
350mm	\$168.00	\$168.00		
400mm	\$186.67	\$186.67		
450mm	\$214.67	\$214.67		

## Welded Drop into Gutter

Diam	1.2mm 304	1.2mm 316		
90mm	\$140.67	\$143.17		
100mm	\$140.67	\$143.17		
150mm	\$165.33	\$169.33		
225mm	\$188.00	\$193.00		
300mm	\$225.60	\$231.60		

# Stainless Steel Tube / Downpipe

# 6 metre lengths as standard

# Charged in 6 metre increments

# 320 grit polished finish as standard

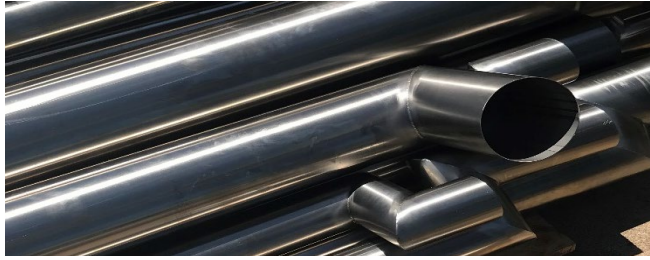

## Per Lineal Metre (6 metre charge)

Outside Diam	304 grade	316 grade
88.9mm x 1.6mm	\$138.67	\$158.67
101.6mm x 1.6mm	\$138.67	\$158.67
152.4mm x 1.6mm	\$168.67	\$228.67
203.2mm x 2.0mm	\$437.33	\$597.33

## Factory Welded Bend

Outside Diam	304 grade	316 grade
88.9mm x 1.6mm	\$112.00	\$112.00
101.6mm x 1.6mm	\$112.00	\$112.00
152.4mm x 1.6mm	\$149.33	\$149.33
203.2mm x 2.0mm	\$186.67	\$186.67

## Factory Welded Sleeve

Outside Diam	304 grade	316 grade
88.9mm x 1.6mm	\$112.00	\$112.00
101.6mm x 1.6mm	\$112.00	\$112.00
152.4mm x 1.6mm	\$149.33	\$149.33
203.2mm x 2.0mm	\$186.67	\$186.67

## T Bracket (3mm) & Clip (1.2mm) To Suit per set

Outside Diam	304 grade	316 grade
88.9mm x 1.6mm	\$54.53	\$57.93
101.6mm x 1.6mm	\$60.93	\$65.63
152.4mm x 1.6mm	\$74.80	\$80.80
203.2mm x 2.0mm	\$83.20	\$91.00

## T Bracket (5mm) & Clip (1.2mm) To Suit per set

Outside Diam	304 grade	316 grade
88.9mm x 1.6mm	\$64.13	\$69.33
101.6mm x 1.6mm	\$75.47	\$82.07
152.4mm x 1.6mm	\$88.80	\$106.30
203.2mm x 2.0mm	\$106.13	\$117.53



---

# Powder Coating

---

# We use the services of two Professional Powder Coaters

# Material is pre treated prior to coating

# Dulux or Interpon Range

# Can offer Warranty on Aluminium or Steel Substrates

# Colour selection catalogue available

# Minimum charge starts at \$120

# Rates start at \$49 per m<sup>2</sup> depending on level of finish required

# Standard Lead time is 5 - 7 working days for coating process

# We can colour match from scratch - lead times and minimum costs apply

## Dulux Duralloy Standard Range - Match Colorbond

# Cost below is additional to Flashing Rates

Girth	per metre
100mm	\$7.50
200mm	\$15.00
300mm	\$22.50
400mm	\$30.00
500mm	\$37.50

Girth	per metre
600mm	\$45.00
800mm	\$60.00
1000mm	\$75.00
1200mm	\$90.00
1500mm	\$112.50

### Notes to Consider

\* Position of hanging holes

\* Length size to avoid warping, especially for narrow profiles

---

## Laser Cutting

---

# We use the services of Professional Laser Cutters as required

# Up to 6 metre lengths

# Any material can be cut

# Minimum charge starts at \$150

# Standard lead time is 5 - 7 working days for cutting process

---

## Galvanising

---

# We use the services of two Professional Hot Dip Galvanising Plants

# Minimum charge starts at \$350

# Standard Lead time is 10 - 15 working days

# Per Kg rate starts at \$3.75



---

# Technical Data

---

Data Sheets available on request for



Colorbond XRW

Colorbond Permagard

Colorbond Matt

Colorbond Ultra

Colorbond Metallic

Galvabond G2

Zincalume G300

Colorbond Coolmax



Duralloy

Duratech

Precious

Electro

Alphatec

Fluoraset